

MAY, 1936

RADIO RETAILING

McGRAW-HILL PUBLISHING COMPANY, INC.

25 CENTS PER COPY

Coming!

A marvelous new line of

MONEY-MAKING MAGIC!

In June you will see the greatest line in all RCA Victor history! Every number is made and priced to conquer a market. Tube for tube, cabinet for cabinet, dollar for dollar, here is a line that will break all records. Highlighting the better sets is a magical new feature, Camden's greatest achievement since the Orthophonic Victrola, joining the "Magic Brain" and the "Magic Eye" to create sensationally new standards in reception—

The new RCA Victor line about to be revealed covers every price class with merchandise that is strikingly superior in appearance, performance, features. Bigger values than ever before! It offers:

28 MODELS

including 6 Consoles under \$100 that will go to town in a big way!

and in sales... This line is so hot it sizzles! Wait until you see it, and get the details of the high-power advertising and promotional plans. Full details will be available to the trade shortly.



RCA MANUFACTURING CO., INC.
Camden, N. J.

A service of the Radio Corporation of America

RCA Victor Means Business

Leadership is no accident *It builds your market*

Millions of MALLORY Condensers
Millions of MALLORY Vibrators
Millions of YAXLEY Volume Controls
Millions of YAXLEY All-Wave Switches

**Millions of these precision-engineered
parts have built a huge market for you**

Mallory pioneered the dry electrolytic condenser—and developed it to its present tremendously efficient form of universal application. Mallory engineering was definitely responsible for the development of the vibrator that made the all-electric automobile radio set a practical achievement. Yaxley Volume Controls and All-Wave Switches repeatedly have set new standards of performance. Mallory-Yaxley engineering has steadily worked towards universal application of radio parts so that—

. . . there has been created for you a vast replacement market which is wide open for intelligent servicing by men who keep abreast with the development of precision replacement parts for universal application.

And Mallory-Yaxley leadership provides that universal application with Mallory-Yaxley Replacement Products that serve the *entire* field efficiently and with astounding precision.

MALLORY

P. R. MALLORY & CO., Inc.
INDIANAPOLIS INDIANA
Cable Address—Pelmollo

YAXLEY

RADIO RETAILING

MAY, 1936

In This Issue

RAY V. SUTLIFF. Editor
 W. MacDONALD. Managing Editor
 T. H. PURINTON. Assistant Editor
 HARRY PHILLIPS. Art Director

•
 HOWARD EHRLICH. Vice-President
 H. W. MATEER. Manager

•
 Tom Blackburn George Tenney
 Chicago San Francisco
 Leonard Church H. S. Knowlton
 Cleveland Boston

THE RADIO MONTH.	9
DEALERS SOUR ON SPIFFS. By W. MacDonald	10
AMERICAN SHORTWAVES FOR AMERICANS	12
FIGURES	15
SALESMEN: MEET YOUR BUSINESS EQUAL By Frank B. Rae, Jr.	16
DISPLAY-MANAGEMENT-ADVERTISING-SELLING	18
HOW MUCH ELECTRICITY?	23
NEWS	25
DISTRIBUTORS IN THE NEWS	29
LETTERS	30
NEW PRODUCTS	33
SERVICE	43
MEN AT WORK	47
HOW TO BUILD ECONOMICAL DECADE BOXES. By G. F. Benkelman	48
SHOP SHORTCUTS	49
TRICKS OF THE TRADE	53
NEW TUBE SOCKET CONNECTIONS	55

McGRAW-HILL PUBLISHING COMPANY, INC.

330 West 42d St., New York, N. Y.

Cable Address: MCGRAWHILL, New York.
 Member A.B.P. Member A.B.C.

JAMES H. MCGRAW, JR. Chairman
 MALCOLM MUIR President
 JAMES H. MCGRAW Honorary Chairman
 HOWARD EHRLICH Vice-President
 S. R. PUTNAM Treasurer
 D. C. MCGRAW Secretary

RADIO RETAILING, May, 1936, Vol. 21, No. 5.
 Published monthly, price 25c. copy. Subscription rates—United States and Central and South American countries, \$2.00 a year. Canada, \$2.00 a year. All other countries \$3.00 a year or 12 shillings. Entered as second-class matter April 10, 1925, at Post Office at New York, N. Y., under the Act of March 3, 1879. Printed in U. S. A. Cable address "McGrawhill, New York." Member of A.B.P. Member of A.B.C. Copyright 1936 by McGraw-Hill Publishing Co., Inc., 339 West 42d Street, New York, N. Y.

Branch Offices: 520 North Michigan Ave., Chicago; 383 Mission St., San Francisco; Aldwych House, Aldwych, London, W.C. 2; Washington; Philadelphia; Cleveland; Detroit; St. Louis; Boston; Atlanta, Ga.

Sales Static IT'S 8 YEARS OLD BUT, BOY, LISTEN TO THAT TONE.

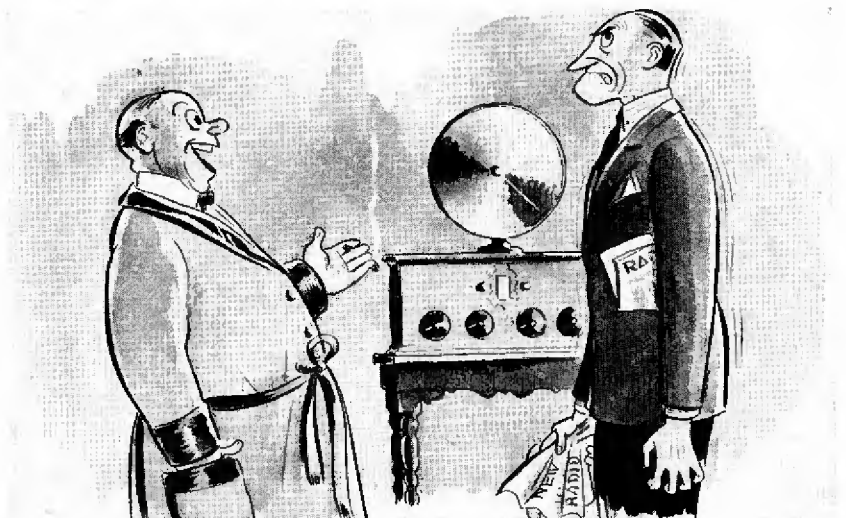

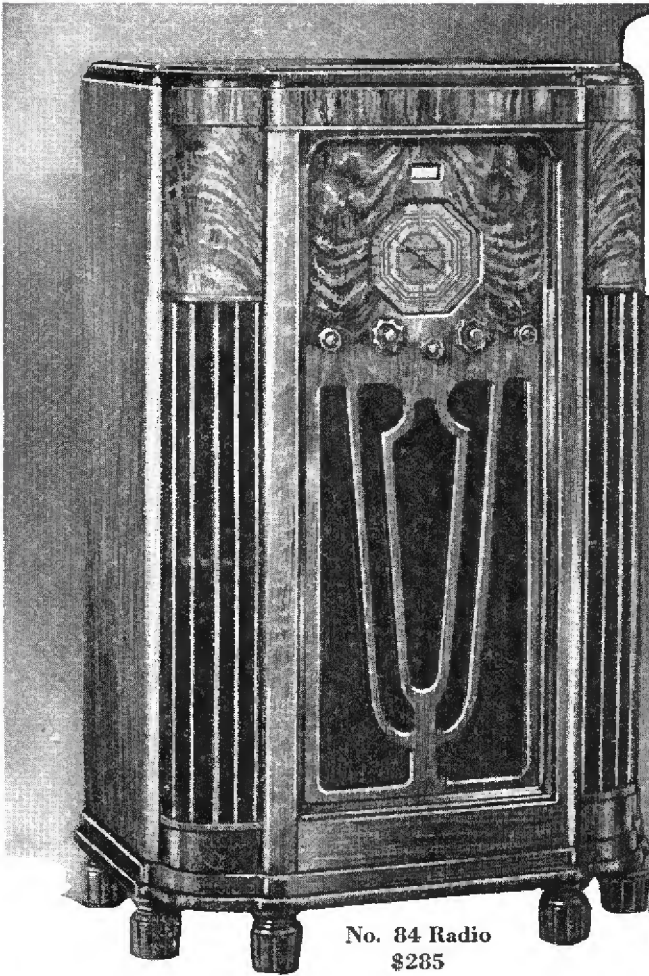

No. 84 Radio
\$285

IT'S EASY TO SELL
BIG UNITS-WITH A
FEATURE LIKE THE
LABYRINTH

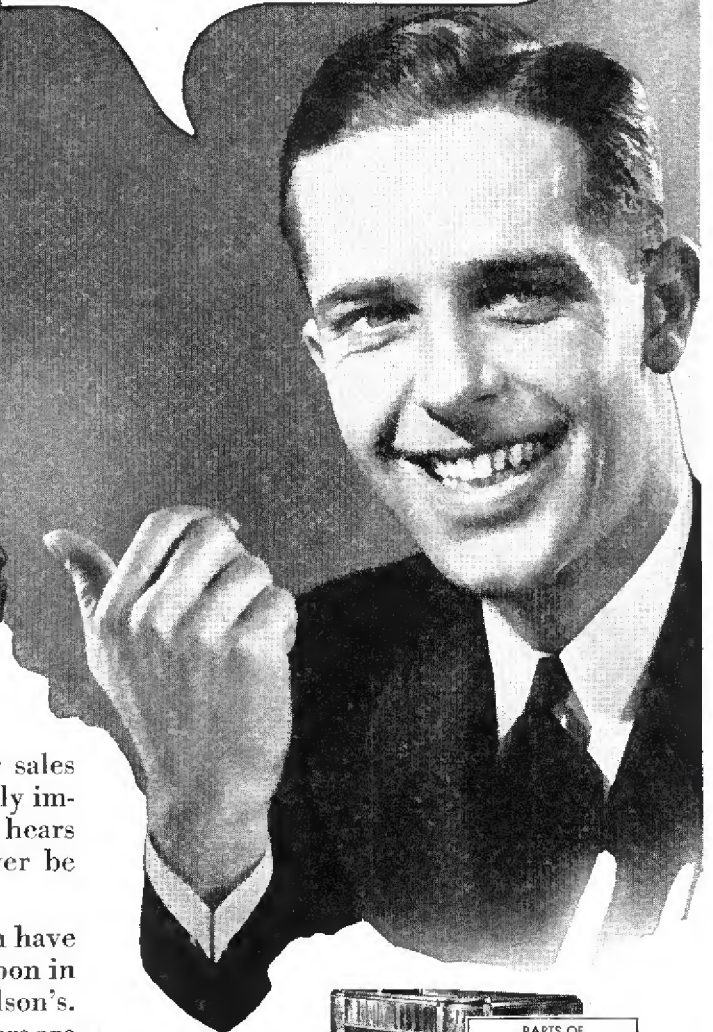

HERE is a feature that makes larger dollar sales easy. The *Acoustical Labyrinth* so markedly improves radio reception that once a prospect hears one of these Stromberg-Carlsons he will never be satisfied with a lesser radio.

No other make of radio has this feature, or can have it. The Labyrinth, the most powerful sales weapon in the radio trade, is exclusively Stromberg-Carlson's. That is why authorized Stromberg-Carlson dealers are selling up and making real profit on every sale. For both dealer and consumer "There is Nothing Finer than a Stromberg-Carlson."

There are 23 Stromberg-Carlson models, priced from \$59.50 to \$985.00, All-Wave Antenna Kit, \$7.00. (Slightly higher southeastern states and west of the Mississippi). Liberal retail finance plan available to all franchised dealers. "There is Nothing Finer Than a Stromberg-Carlson."

STROMBERG-CARLSON TELEPHONE MFG. CO., ROCHESTER, N. Y.

THE ACOUSTICAL LABYRINTH

This exclusive Stromberg-Carlson feature takes the unnatural boom out of radio voices and music, and provides deep bass notes with a new fidelity.

The long, winding passageway of the Labyrinth, lined with a special acoustical material, takes the place of the usual box-like cavity in the cabinet which is the

source of the exaggerated boom in the low tones.

The air passage of the Labyrinth is so tuned and proportioned that it not only removes this exaggeration, but greatly extends the range of bass notes that are effectively reproduced. The Labyrinth also increases the volume capacity and accuracy of the loud speaker.

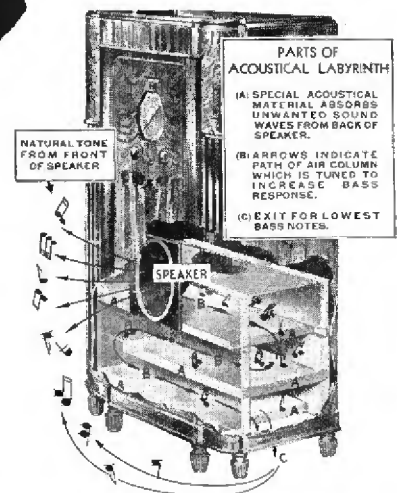

Stromberg-Carlson



MADE RIGHT

"When you sell a Tung-Sol tube
you make a satisfied customer."
MOBILE AUTO RADIO CORP.
L. C. Armstrong, Detroit, Michigan

SOLD RIGHT

"Tung-Sol looks out for my interests so I look
out for theirs, and it has paid both of us."
RADIO ELECTRIC OF THE ORANGES
9 Washington St., East Orange, N. J.

There are still desirable locations where independent radio retailers and service organizations could qualify as Tung-Sol retail agents. Write our nearest sales office. They will give you details promptly.

RADIO RETAILING, MAY, 1936

TUNG-SOL

Tone-flow radio Tubes

TUNG-SOL LAMP WORKS, INC.
Radio Tube Division

SALES OFFICES: Atlanta, Boston, Charlotte,
Cleveland, Chicago, Dallas, Detroit, Kansas
City, Los Angeles, New York
General Office: Newark, N. J.

PAGE 3

THERE'S Rhythm IN EVERY

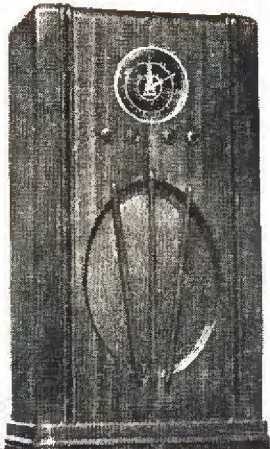

Rhythm SENIOR Model 527
 Five meta-glass tubes. Standard band and foreign short wave. Walnut console 35" high, 18 3/4" wide, 9 1/4" deep. Eight-inch speaker. List: \$49.95.
 Model 527-B, same as above, for six-volt battery: \$54.95.

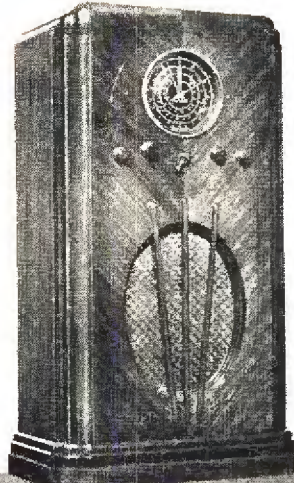

Rhythm MASTER Model 627
 Walnut console 38" high, 21" wide, 11 1/2" deep. Six meta-glass tubes. Three-band, all-wave dial. Full-range 10" speaker. List price: \$69.95.
 Model 627-B, same as above, for six-volt battery: \$84.50.

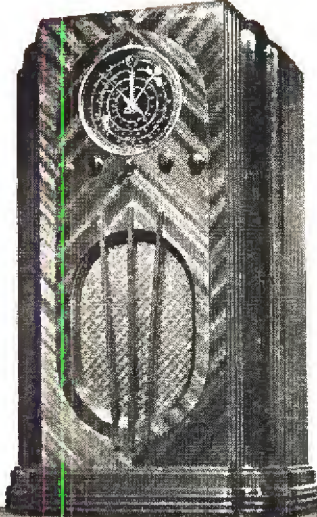

Rhythm QUEEN Model 927
 Walnut console 40" high, 23" wide, 11 3/4" deep. Nine meta-glass tubes. Three-band, all-wave dial, "Electric Eye," full-range 12" speaker. List: \$99.50.

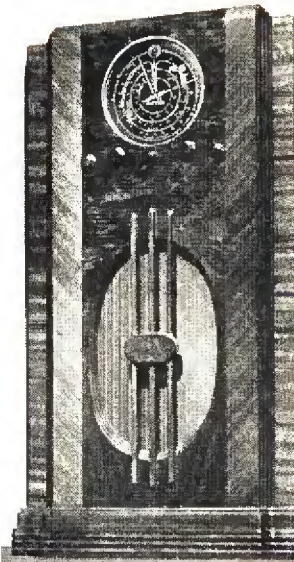

Rhythm KING Model 1127
 Walnut console 42 3/4" high, 25" wide, 12" deep. Eleven meta-glass tubes. Three-band, all-wave dial, "Electric Eye," full-range 12" speaker: \$159.95.



Rhythm BABY Model 417
 Four-tube AC table set. Standard and police bands. Walnut cabinet 11 3/8" high, 9 1/4" wide, 7 1/4" deep. Five-inch speaker. List price: \$19.95.
 Model 407, four-tube AC-DC. Standard & police. List: \$19.95.

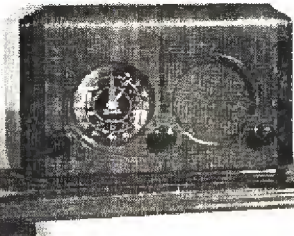

Rhythm BELLE Model 467
 Four-tube AC table set. Standard and police bands. Walnut cabinet 8 3/8" high, 13 1/2" wide, 7 3/4" deep. Five-inch speaker. List price: \$24.95.
 Model 507, five-tube AC-DC. Standard & foreign. List: \$29.95.

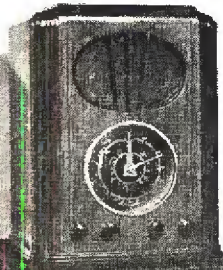

Rhythm JUNIOR Model 517
 Five meta-glass tube table set. Standard band and foreign short wave. Walnut cabinet 17 1/4" high, 13 3/8" wide, 9" deep. Six-inch speaker. List: \$34.95.
 Model 517-B, same as above, for six-volt battery. List: \$39.95.

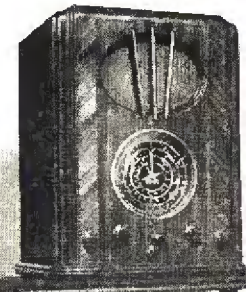

Rhythm MAID Model 617
 Six meta-glass tube table set. Three-band, all-wave dial. Walnut cabinet 21 1/4" high, 13 1/4" wide, 12 1/4" deep. Eight-inch speaker. List price: \$59.95.
 Model 617-B, same as above, for six-volt battery. List: \$64.95.

PUT RHYTHM IN YOUR SALES

DETAIL OF THE 1937 LINE OF

ARVIN Radios

Wrapped up in that one little word—rhythm—are the sound reasons why this new 1937 line of Arvin Radios will sell and make extra profits for every dealer who stocks them, regardless of other lines he may carry.

There's Rhythm in Arvin's Eye-Catching Beauty

A pleasing, modern rhythm of design gives all models a definite Arvin "family resemblance"—yet each one is a smartly styled individual in its own right. Beautiful natural woods of unusual grain, and appealing cabinet lines, harmonize perfectly with the scheme of things as a woman sees them in her home.

There's Rhythm in Arvin's Ear-Pleasing Performance

The rhythm of every part working together perfectly is expressed in the tone, selectivity and station-getting ability of every model. No mystery or magic about Arvin's splendid features. Large rich-toned speakers, of course. Built-in aerial tuning system in all-wave models. Jumbo, open-face, reverse lighted dial—easy to see and tune. Oscillograph ray tube, or "electric eye" station tuning featured in the two large models. And all the other newest developments in radio.

There's Rhythm in Arvin's Purse-Fitting Prices

There's rhythm in the range of Arvin's prices—from \$19.95 for the compact 4-tube Rhythm Baby, standard and police-band table model, through a proportionately moderate scale to the big, impressive Rhythm King for those who want an 11-tube all-wave console model—at \$150.00.

The new Arvins have rhythm in everything—in appearance, performance, and price—the rhythm that people want in the radios they buy. There's a model to suit every desire. Stock Arvins this year and take advantage of the extra profits this splendid line will make for you. See your jobber or write us for complete information.

NOBLITT-SPARKS INDUSTRIES, Inc., Columbus, Indiana

All prices are list—slightly higher west of Denver

Sell Arvin "Tailor-Fit"
AND MAKE MONEY ON CAR RADIOS



Overhead, separate case, or in-the-set speakers with steering column or matching panel controls. Everything to meet every requirement. Any combination your customers want. Prices as low as \$39.95. See a nearby Arvin jobber for full information.

WITH ARVIN!

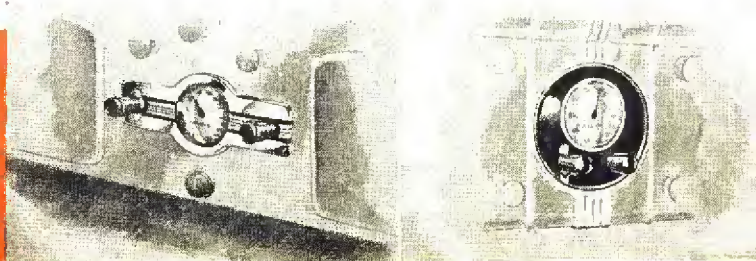

a new standard of comparison

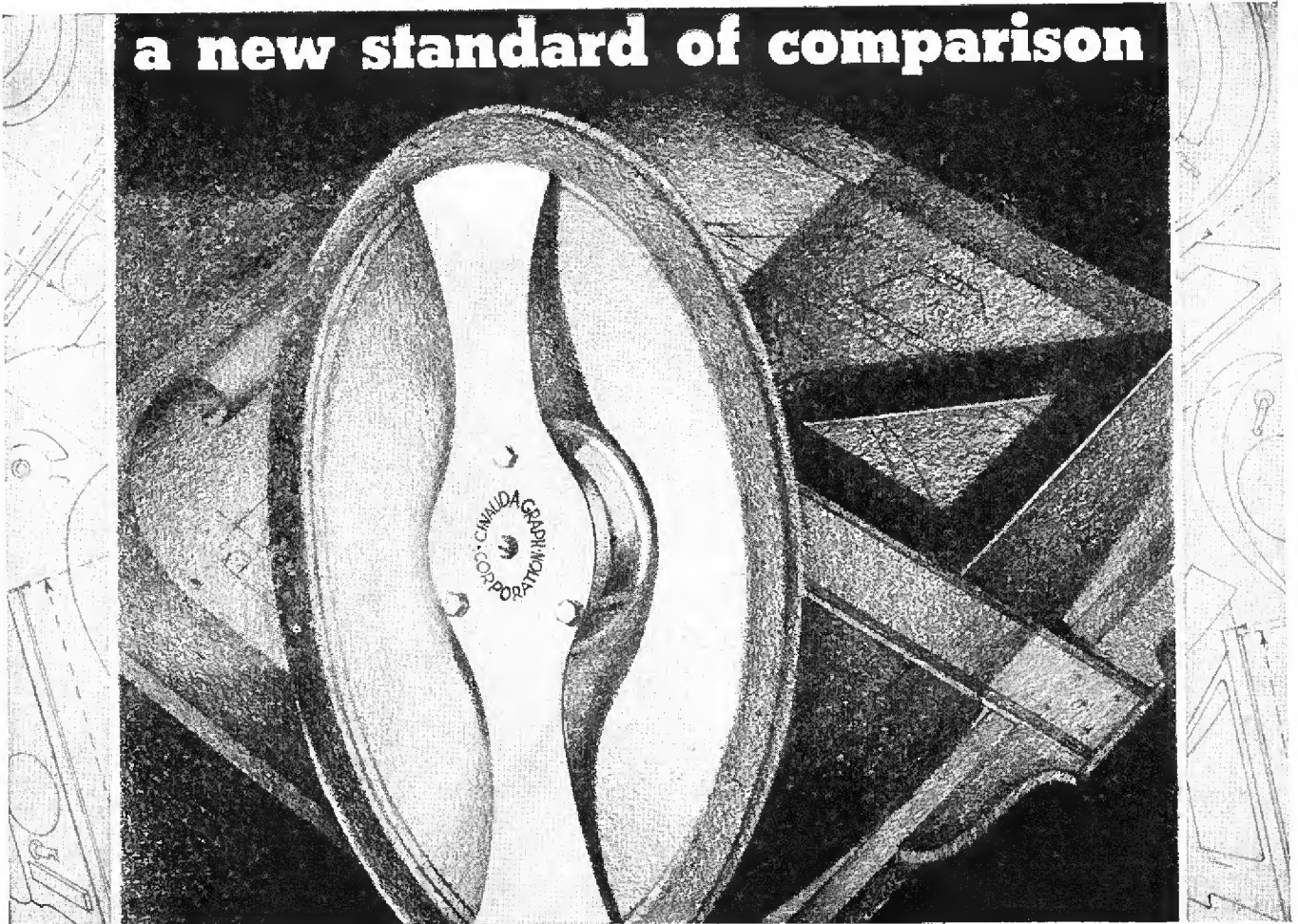

Magic Magnet Speakers



A new design . . . a new conception of speaker reproduction . . . a new sales force in the speaker field. Lay any yardstick of comparison alongside the Cinaudagraph Magic Magnet Speakers that you will . . . test them . . . compare them . . . prove to yourself that this new speaker line is the standard by which conventional speakers are henceforth to be measured. In high-fidelity reproduction . . . equal to electro-dynamics of comparable dimensions: in compact and sturdy assembly: in price range that is amazingly low . . . the Magic Magnet Speaker is new! Write today for complete data on the merchandising capabilities of the Cinaudagraph 8, 10, 12 and 18" Magic Magnet Speakers.

CINAUDAGRAPH CORPORATION

SPEAKER DIVISION, DEPT. R
STAMFORD, CONN., U. S. A.

WINCHARGER FARM PAPER ADVERTISING

PACKS A WALLOP

5,000,000 farmers are going to read attractive Wincharger display ads this year.

Through these ads thousands will buy new 6-volt farm radios.

If you want your share of this profitable 6-volt radio business, sell them the easy Wincharger Way. It's a leader—It's a closer.

New last year — internationally known and recognized this year.

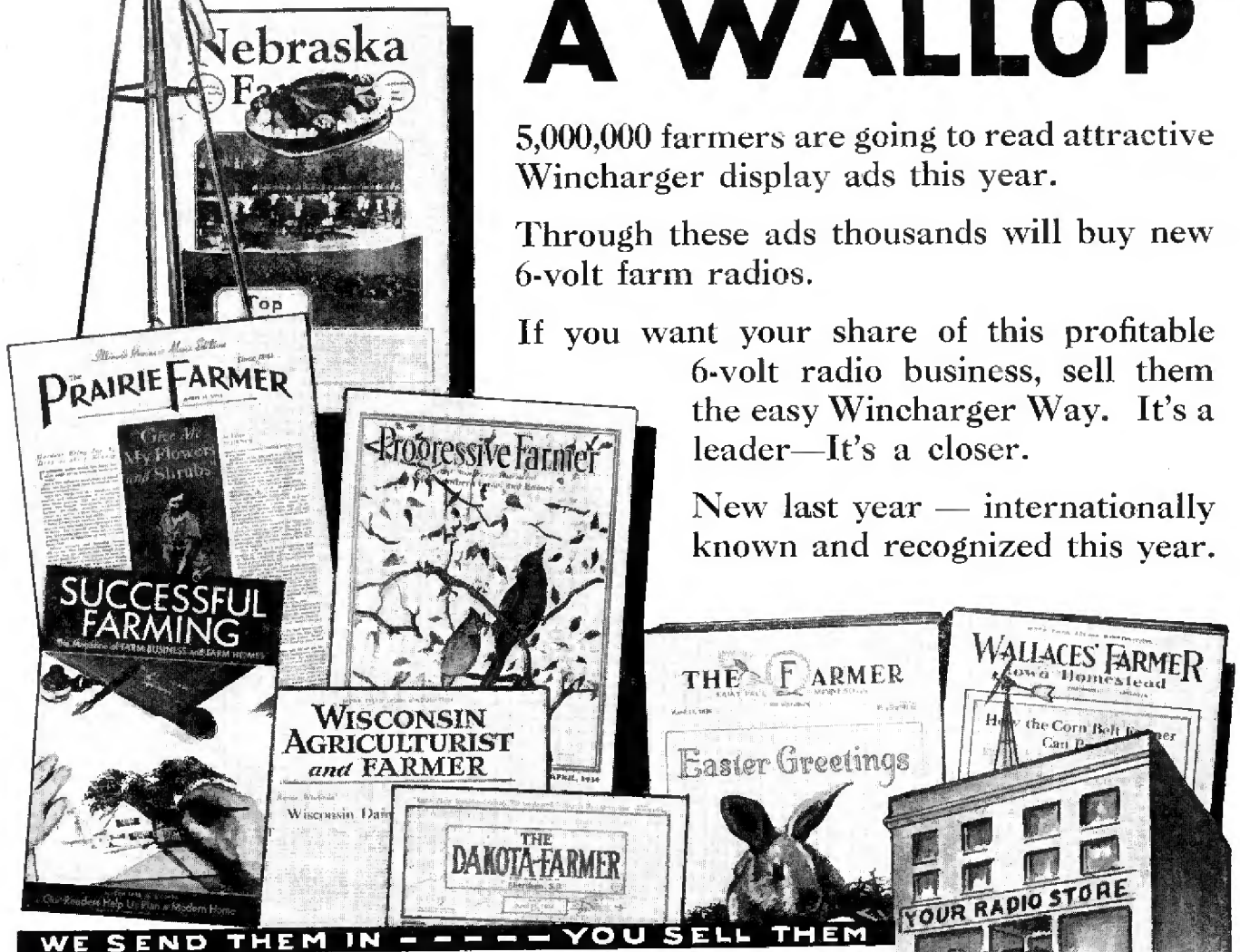

WINCHARGER
CORP.
2702 Hawkeye Drive
SIOUX CITY, IOWA
U. S. A.



**5,000,000
UNWIRED FARM
HOMES
LET'S SELL THEM**

World's Largest Manufacturers of Wind Driven Battery Chargers.
Manufacturers of 32-volt Winchargers Since 1927.
Write for Complete Information on 32-volt Plants.

MARKETS

SPORTS

POLITICS

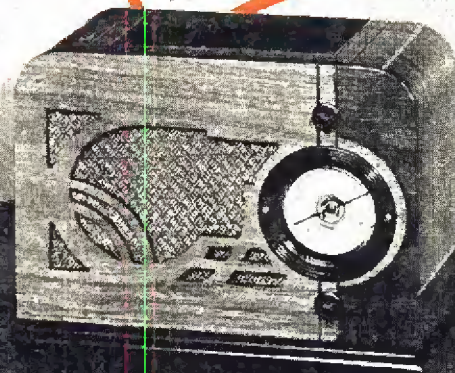

3 Good Sales Arguments **for a BELMONT Office Radio**

All the average business man needs is a good excuse to have an office radio. Market reports furnish the alibi; sports and politics, the incentive to buy!

The Belmont Model 601 is designed specifically to meet the needs of executives as an office set or second receiver for their homes. It is a small but powerful a-c—d-c superhet' with avc and operates on a short flexible aerial.

Take advantage of the political interest, baseball, and markets to sell the Belmont Model 601.

BELMONT RADIO CORP.
1257 W. Fullerton Ave., Chicago, Ill.
Cable Address, *Belrad*

BELMONT

THE DEPENDABLE

RADIO

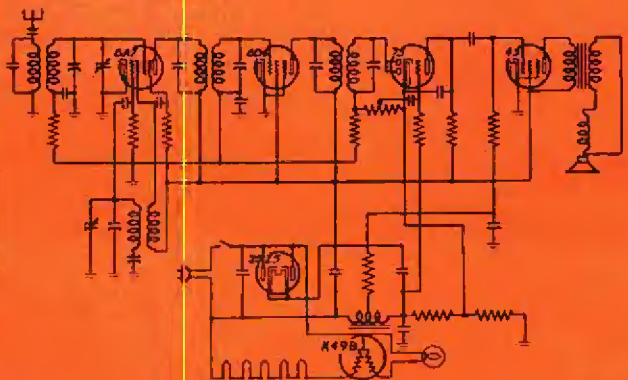

This circuit diagram, typical of Belmont design, tells its own story to your servicemen.

THE RADIO MONTH

Merchandising

Auto-radio sales spurt, refrigeration also up

"International" stations to spur shortwaves

..... Emulating the gent on the flying trapeze, retailers exhilarated by the first whiff of spring are swinging as gracefully as possible to auto-radio and refrigeration, exhibit interest in battery portables for the first time in many years. Midget-sized car sets with built-in controls, at around \$20, have caught the public eye and are giving upper-bracket merchandise a stiff tussle.

Watch the trapeze swing back over to home sets when newspapers whoop up political conventions in earnest about the middle of this month.

..... Packaged sound equipment appears to be sweeping home-rolled stuff right off the boards at last and mail-order houses assembling equipment for widely distributed catalogs appear to be the manufacturers' sole remaining competitive problem. Specialists constitute the nucleus of the business, but coming in for keen scrutiny are methods of training radio servicemen and electrical contractors to sell and finance.

The market for sound equipment has hitherto been largely in entertainment fields. Industrial and educational uses are coming up fast and we predict that they will eventually rate position number one.

..... The Government has scheduled a June 15 meeting in Washington at which it appears American

shortwave stations will be given the significant designation "International Broadcasting Stations." Re-assignment of frequencies is to be taken up and we wouldn't be surprised to see a minimum power ruling go through, designed to weed out small transmitters that clutter up the already too-narrow channels.

Widespread use of allwave receivers now assures broadcasters of an audience and this meeting may be the first step in a program which will eventually permit shortwave stations to sell time and put out their own sponsored and sustaining stuff.

News

Speaker field in flurry over new permanent magnets

Gas generator business attracts new makers

..... Three months ago two manufacturers comparatively unknown to the radio business hopped right into the limelight with permanent magnet dynamic speakers using ultra-efficient metal fields. Despite the fact that the patent situation is far from clear, assurances of quantity delivery difficult to obtain and prices one-third or more higher, interest among set makers is running so high that old-line speaker manufacturers have found it expedient to bring out similar designs.

Even manufacturers of a.c. speakers evince interest.

..... Another new product stirring up nationwide interest is the gas-engine charger. Genemotor people started the flurry, made the electrical parts themselves and bought the engines. Now makers of gas engines

for washers and outboard motorboats exhibit interest, buy electrical parts from the radio and automotive field.

Most farmers expect the government to electrify their sections almost any day. So they won't bury \$250 or more in a light plant. But they will buy \$60 units to tide them over, run lights, operate small appliances. And after the gas charger sale comes wiring, fixtures, radios.

..... "Sell Through Service" is becoming more and more the watchword of the radio retailer. Reinstatement of repair departments in retail stores is very much on the upgrade because (a) service contacts are an effective, inexpensive means of unearthing new prospects for set sales; (b) independent servicemen have proven to the dealer's satisfaction that it is not necessary to lose money on such work, and (c) the retail radio business is narrow enough, without lopping off this profitable branch.

Service

Agitation for tube tester standards

..... Much needed are tube tester standards and there is considerable agitation among makers of both tubes and testers at the present time. It seems that certain devices test tubes made by manufacturer A better than those made by manufacturer B. And in a high-grade laboratory machine both makes show up equally good.

The problem is a tough one for the instrument men, as it is difficult to do a real testing job at prices the boys in the retail field can afford to pay.

DEALERS SOUR



LAZARNICK

When a factory man, masquerading as a shopper, goes so far as to pay a clerk spot cash for mentioning *his* line first, the dealer naturally wonders who is directing the salesforce

O N S P I F F S

GRASP a lion firmly by the tail. Swing, describing a vicious circle, and competition for that particular spot in the arena will streak for the nearest exit. It is comparatively safe, too. So long as you keep swinging. And so long as everybody else obligingly refrains.

That's where the game becomes slightly complicated; everybody else won't. For just as soon as the boys can locate unengaged livestock they will insist upon playing Tarzan, too, with the result that shortly thereafter the place runs buckets of blood.

Here, as Frank Buck might describe it, is the precise position of the radio manufacturer relative to Spiffs . . . bullion, britches or boat-rides awarded to retail radio salesmen, with

Subsidizing of retail salesmen by manufacturers and distributors against store's interests . . . Bonuses aimed at competitive lines do not aid volume . . . Extra commissions on higher-priced models constructive

By W. MacDonald

or without the dealer's knowledge, in return for most-favored-nation treatment.

The whole thing began when manufacturers realized that the retail salesman was at once the weakest and most important link in the entire sales chain, started sending him bulletins containing sales ammunition on a particular line or model. From this to medals, cherished for the glory rather than the shekels they would bring at Uncle's was but a step. Legitimate, constructive promotion everybody called it. And constructive it was.

Then some bright soul started saying it with cash and probably wishes to hell he had strangled the idea at

birth. For, today, the retail salesman is in the pay of so many manufacturers, who slip him the mazuma in so many ingenious ways, that he is of particular value to none.

A promotion stunt considered brilliant at its inception is now as costly as blazes. One company puts up a premium of a buck. Another jacks

it to two and a straw hat. A third triples the greenback ante, throws in a trip to Mars.

Manufacturer Hooked

According to our well-oiled grapevine telegraph, 92 per cent of the major manufacturers in the business use Spiffs in one form or another. Cost ranges from 2 to 5 per cent of wholesale billings. Some started swinging the lion with their eyes wide open. Others simply copied the idea without considering its ultimate consequences. And still others were forced into it. Practically all of them would like to let go but don't dare.

Read this from one of the best-

92% of the set manufacturers use spiffs

4% of wholesale billing is estimated cost

74% of the dealers dislike such plans

6% think abuses might yet be controlled

96% of all distributors have tried Spiffs

85% employ them at the present time

71% wish they were well out of the mess

known men in the game, who admits his company has been no lily:

"From the cost angle, I believe that the competition between manufacturers to out-do each other in setting up attractive prize campaigns is running this form of sales promotion expense much over the amount that should be spent. This additional expense has to come from somewhere and rather than reduce necessary advertising expenditures or other legitimate forms of promotion the tendency is to take it out of the product.

"One very bad feature from the cost standpoint is that it is impossible to estimate or budget the cost of a campaign of this kind in advance. There is no way of knowing how many salesmen will win all or part of the prizes set up and not until the campaign has closed are expense figures available. Furthermore, any Spiff campaign involves an increased amount of bookkeeping to control padding and false reports. When gypping is exposed, as it quite frequently must be, the manufacturer has made a permanent enemy out of that particular retail salesman.

"While the Spiff idea emanated from the ranks of the manufacturer, admittedly, dealers have indirectly forced it in some instances. Most dealers have not been farsighted enough to adopt a sliding-scale of commissions for their salesmen. Commissions should obviously increase in the higher brackets as selling-up is extremely important to the store and should be encouraged.

"There are certainly two sides to this problem as there is need for defi-

(Please turn to page 38)

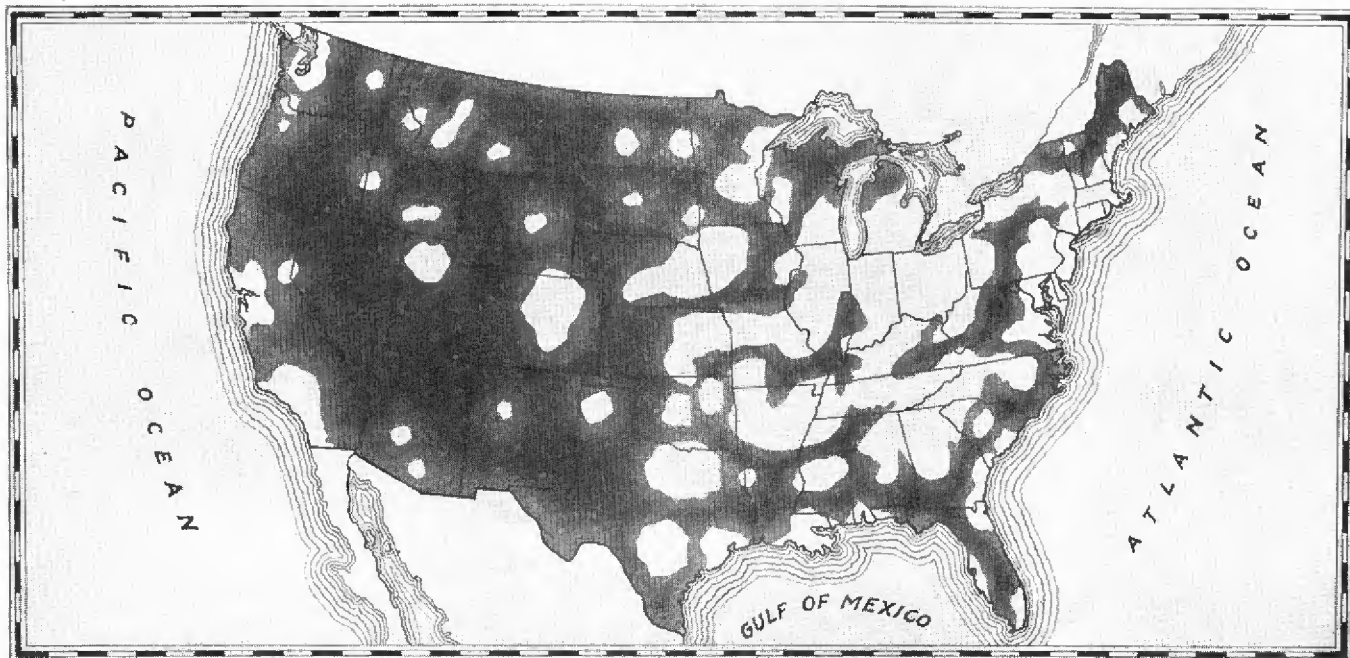

ABOVE—In these shaded areas, 65 per cent of the United States, no program service of primary signal strength is available from regional or cleared channel stations



LEFT—Oswald F. Schuette, president of the Short Wave Institute of America, Washington, D. C. His constructive suggestions are incorporated in this article

RIGHT—Walter S. Lemmon, founder and president, World Wide Broadcasting Foundation, at transmitter panels of 10,000-watt shortwave station, WIXAL, Boston



AMERICAN SHORTWAVES FOR AMERICANS

TODAY the bulk of our radio sales must be made in a replacement market! The dealer first must convince the customer that his present set is not up to scratch . . . and many of these 1928-1933 receivers still perform mightily well—on longwave.

What talking point is strong enough to break down this resistance, to cause Mr. Jones to spend real money for a new radio?

Improved tone, appearance, sensitivity? These are not sufficient.

The answer is to sell, and sell hard,

the *new* services—American short-wave programs for Americans, and the modern multi-wave receivers.

Why? Because only the latest set will give this PLUS value—will enable the daytime listener and those in poor reception areas (some 10,000,000 prospects—see map) to hear the big programs with clarity and signal strength the equal of that right in the shadow of WEAF. And 85 per cent of all standard wave, big chain programs are now relayed on these shortwaves.

Already the set makers have awakened to this situation. Next month one of them will announce an entirely new type of sw dialing and major improvements in the circuit end. Writes another well-known concern: "We think it a very good idea that you promote American shortwave programs in this country. Right along these lines our engineering department is working on some new receivers designed expressly to tie in with this thought."

Last month we wrote all the manu-

facturers outlining this new sales approach to the old-set owner prospect. Without exception they heartily endorsed it. The following response is typical:

"I think your idea on American shortwaves as expressed in your letter of March 26 is exceptionally good. I would suggest that all radio set manufacturers incorporate the high spots in their advertising material."

ROSS D. SIRAGUSA
Continental Radio & Television Corp.

All signs indicate that this shortwave feature will be a big factor in our 1936-37 selling season. There now are 28 American shortwave transmitters affiliated with the big standard wave stations and re-broadcasting the best programs on the air. In addition, one shortwaver, W1XAL, Boston, originates its own programs of outstanding quality and is growing in popular favor by leaps and bounds.

But this is not all. Foreign shortwave broadcasters, particularly in Europe and South America, are improving their transmitters, increasing their power and putting on finer programs each month.

And lastly, if the experiments in the high frequency fields, the "apex" wave lengths above 30,000 kilocycles, prove successful there will be a further enlargement in the market for new types of receivers.

The Dealer's Obligations

What must dealers do to get the benefit of this new public interest in the shortwaves?

First, they should be able to give to their customers comprehensive and authentic information concerning the vast wealth of the programs now available in the shortwave field.

Thanks to the efforts of the Radio Manufacturers Association, the radio columns of most of the daily newspapers publish an admirable selection of daily high lights from the international programs. No compilation of such high lights, however, can do more than suggest the wide variety and the fine quality of these programs themselves. For instance, the British shortwave stations operate 16 hours a day, other nations even longer.

The radio dealer who wants to sell

shortwave receiving sets should acquaint himself with the details of the principal European and South American programs. He should be in a position to tell his customers that the British stations, for instance, make a practice of repeating at convenient intervals, by electrical recordings, their broadcasts of outstanding international events.

Next, dealers should master the exact requirements of shortwave tuning so they may educate their customers to the art of tuning slowly and precisely. Much of the dissatisfaction which has been recorded by shortwave customers has been directly traceable to the fact that they did not know how to tune their sets, and that dealers did not teach them this important item.

Then there is the ticklish, but important question, of installation. Ordinary broadcast receivers may be set up anywhere with an antenna dropped out the nearest window. Shortwave receiving sets demand finer adjustments. The customer will find the cost of expert installation a profitable investment. The best rule would be for the dealer to sell shortwave receiving sets for a price that includes a shortwave aerial and expert installation—see picture on page 47.

What should the manufacturer do to get the benefit of the public demand and make 1936 a "shortwave year?"

The first problem is that of the dial. Engineers may think the dial unimportant. The public does not. All it sees is the dial.

The dial should tell a complete story. Each band should be so designed that the set owner will need no diagram to find what he wants. It should be so calibrated that he can tune with precision to an exact wave length and enter this dial setting in his log book.

Dials for shortwave receiving sets have received a lot of attention from the manufacturers during the last year. The newer sets give evidence of the care they have taken to solve this problem.

Improvements in Shielding

Another field requiring the attention of the manufacturer is that of protecting shortwave sets against electrical interference which increases when operating at higher frequencies. Passing automobiles can play havoc over a sizeable area in the 16- and 19-meter bands. Part of this problem of protection can be solved by the engineers of the industry. Other aspects may have to be cared for by legislation.

Another difficulty is interference among the transmitters on the shortwave bands themselves. Here the solution is not so simple. No shielding within the set can serve to separate overlapping frequencies in the

Big-time programs now re-broadcast by allied shortwave stations give better reception in remote areas—Sales resistance to new sets best overcome by improved sw service argument

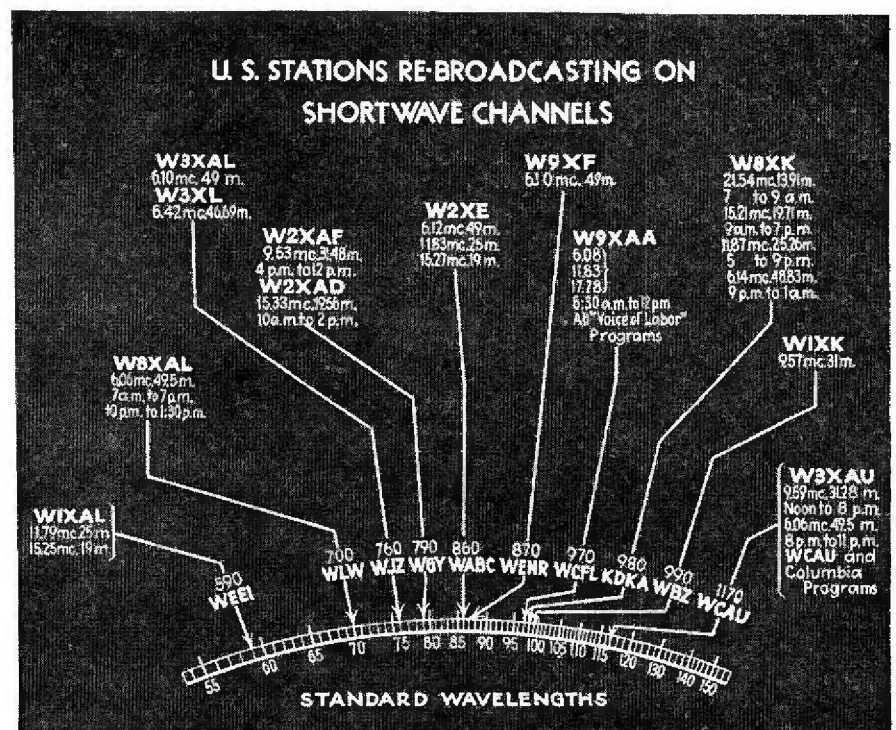

crowded bands. Only international action can relieve this heterodyning. The Federal Communications Commission has already taken steps to bring this matter up for international action. In the meantime, many of the important foreign broadcasting stations are negotiating among themselves to end the more serious aspects of this interference.

Again, the manufacturers must contribute their share in the problem of shortwave program distribution. It is doubtful whether the newspapers will ever devote space enough to shortwave programs to give the public an adequate summary, in spite of the fact that programs which emanate from London, Paris, Berlin, and Rome are as "local" to Terre Haute, Indiana, as any eastern station.

Station WIXAL

HOW many radio dealers realize that when they sell a new all-wave set they also are giving an admission ticket to a college education; that the owner of a shortwave set can get free instruction in English, history, science, language, art and world affairs?

There was established recently a new plan of broadcasting, a pioneer project in radio, which has already attracted more than 500,000 listeners in all parts of the world and which is supported *free of advertising*.

Shortwave Station WIXAL, because of its non-commercial nature has its studios in the University Club, Boston. Here, on regular schedules during the college year, noted professors from many of the best universities prepare courses of instruction for radio listeners in thousands of remote places where local educational opportunities are few. These programs are presented in interesting form by broadcasting experts so that they are just as thrilling as many of the best features on the broadcast band. Even the music is designed to uplift the listener, to cultivate his interest in better things. Attention is given to the works of great composers and appreciation of music as an art of expression. Short interludes of music are provided between the instruction courses to furnish a change of topic.

All of this work is the result of the dream of the founder of WIXAL, Walter S. Lemmon, a prominent radio engineer of New York City. Mr. Lemmon first conceived this idea of providing international good will

and education by radio 17 years ago when serving in the Navy as special radio officer to the late President Woodrow Wilson.

WIXAL now operates with 10,000 watts of power. During the winter months it uses 6.04 megacycles and may be found on the shortwave dial about midway between Berlin 6.02 and London 6.05 megacycles. For daytime transmissions 11.79 mc. or 15.25 mc. are used.

I Bought A New Set To Get Your Programs

Thousands of letters of appreciation for these high type programs have been received from many American listeners. Illustrating the sales value of this station is the following:

"I bought a new, modern set so I could listen to your programs. Like their high standard, clarity of reception and absence of advertising. Your broadcasts are a regular feature of our home life."

A LISTENER IN NEBRASKA

The radio dealer is doing a lasting service to his customer when he tells him about WIXAL and these educational programs. Since they can often be picked up with "local" strength in all parts of the USA, the customer can tune his new set to this powerful station and get programs which cannot be obtained otherwise.

The studios of WIXAL in the

Daily News Broadcasts From Europe in English

<i>Eastern Standard Time</i> A.M.	<i>Country</i>	<i>Frequency (megacycles)</i>
1:55	England	9.51 & 11.82
3:45	France	11.88
4:30	Germany	9.54 & 15.2
6:00	France	15.24
7:00	Germany	9.54 & 15.2
8:00	England	17.79 & 21.47
9:00	Germany	9.56
9:00	Italy	11.81
10:55	England	15.14 & 17.70
P.M.		
1:00	England	9.51; 11.75 & 15.26
1:30	Italy	9.63
1:30	France	11.88
2:00	Germany	6.02 & 11.77
3:40	England	9.51; 11.75 & 15.26
4:00	Germany	6.02 & 11.77
5:15	Spain	9.87
6:00	Italy	9.63
6:30	Spain	9.87
7:00	France	11.72
7:40	England	9.53; 11.75 & 15.31
8:15	Germany	11.77
10:00	France	11.72
10:45	England	9.58 & 11.75

Prepared by Short Wave Inst. of America

Because of the regularity of these news programs and the power of their stations, they serve as an ideal dial position guide for other foreign broadcasts.

University Club, Boston, originate all its programs. Here again this American station is unique. Most domestic shortwave stations simply rebroadcast programs of the local stations. WIXAL designs programs of interest to shortwave listeners abroad, as well as in all parts of North America. In many cases these programs are so valuable that WIXAL has had requests for permission to carry them over local New England stations.

One of the purposes of WIXAL is to provide shortwave programs which will give a proper impression of American ideals, culture and education to people in other countries. It is important to international good will that we do not allow programs to go out over the shortwave that will offend our neighbors. Mr. Lemmon believes that the value of radio is so important a factor in international relations that we shall soon see the desirability of submitting all shortwave broadcasts to the approval of the State Department.

WIXAL takes a world viewpoint and presents a news program each weekday except Saturday and Sunday at 5:30 p.m., E.S.T. This reaches Europe at about 10:30 p.m. and can be intercepted in all parts of North America. For these international news broadcasts a frequency of 11.79 mc. is used with a powerful double beam antenna which covers Europe and most of the USA, as well as Central America and the West Indies.

To provide for a steady continuation of these educational programs on a larger scale, the World Wide Broadcasting Foundation was recently formed with a board of trustees and academic committees to supervise all programs. Its Educational Committee includes President Dr. William M. Lewis of Lafayette College, a famous astronomer; Dr. Harlow Shapley of Harvard Observatory, and a radio engineer, the founder of the project, Mr. Lemmon. For the support of these educational programs, free of advertising, the Rockefeller Foundation has extended a grant during the formative years of this new project.

It is hoped, however, that thousands of listeners who obtain benefit and enjoyment from these programs over their "all wave" radios will desire to contribute small amounts annually to assist in the growth of this non-profit station. A Listeners Club has been formed to which members subscribe a minimum of two dollars yearly. This brings them detailed printed programs in advance each month, and instructional material.

FIGURES

RADIO RETAILING'S MONTHLY BUSINESS BAROMETER

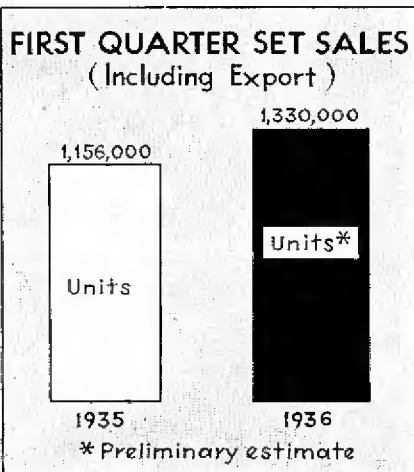

TAX COLLECTIONS

Excise tax collections by the Internal Revenue Bureau from radio manufacturers, first quarter, were \$1,360,861 as against \$941,978 in 1935, an increase of 44.5 per cent. March collections ran \$336,043 as against \$350,334, a decrease of 4 per cent.

DESIGN VS. DEMAND

From analysis of figures supplied by ten typical manufacturers who offered complete, new lines last September we obtain this interesting contrast:

The average set maker approached the season with 51 per cent of his models table types, 49 per cent consoles. Actual production to date runs 64.2 per cent table models and 35.8 per cent consoles.

Average list price of models offered in September was \$72. Average list price of models actually shipped to wholesalers as of April 1 was \$57.

22,869,000 HOMES

On January 1, 1936, there were 22,869,000 radio-equipped American homes, according to a report just rendered by the Joint Committee on Radio Research, American Association of Advertising Agencies, Association of National Advertisers and National Association of Broadcasters. (*Radio Re-*

tailing estimated 22,400,000 in its January issue.)

There were 21,456,000 homes with radio on January 1, 1935, says the committee, hence 1,413,000 were equipped during 1935.

APPLIANCES UP

Refrigeration hit an all-time high for the month of March, 1936, rising 27.5 per cent above March, 1935, unit sales, according to an estimate prepared by the Edison Electric Institute from National Electrical Manufacturers Association figures.

The latter organization reports, further: Electric range sales up 45.8 per cent for February, 75.4 per cent for March. Water heaters up 53.4 per cent in February and 47.2 for the first quarter.

The American Washing Machine Manufacturers Association advises that March, 1936, electric washer sales spurted 25.5 per cent above March, 1935, first quarter advance being 24.2 per cent. From the same source we hear that gas-engine driven washers fell 3.2 per cent short in March but exceeded the previous year's first quarter by 1.3 per cent.

AUTO-RADIO BUSINESS BY CARS*

FORD	15. %
1936 CHEVROLET	13.6
PLYMOUTH	10.3
DODGE	7.9
(Unidentified)	6.9
1936 OLDSMOBILE	6.3
1935 DODGE, PLYM. CHRY. DE SOTO	5.8
1936 PONTIAC	5.
1935 CHEVROLET	3.9
1936 TERRAPLANE	3.8
1936 BUICK	3.4
STUDEBAKER	2.4
NASH, LAFAYETTE	2.4
1936 CHRYSLER	2.3
DE SOTO	2.1
PACKARD	2.
1935 TERRAPLANE	1.7
AUBURN	1.7
1936 LA SALLE	1.5
1936 GRAHAM	1.
1936 GRAHAM (110)	.9
1935 HUPPMOBILE	.1

*From January-April records of a major set manufacturer

Vacuum cleaners of the floor type upped 25.7 per cent in March, hand cleaners showing a 22.7 per cent increase. First quarter report on floor types indicates a rise of 21.4 per cent, hand types 19.5 per cent.

SERVICE STATISTICS

During the year 1935, the Public Service Company of New Jersey, according to Allen W. Hawkins, received 1,900 complaints of radio interference. Of this number 28 per cent were cleared up either by the consumer or by local men before the utility could investigate.

Checkup on the remaining complaints divulged that 29 per cent were the fault of the set itself, 28 per cent were due to noise created by electrical appliances or equipment operated by neighbors, 23 per cent of the noise came from appliances or equipment owned by the complainant, 16 per cent from power line trouble and 4 per cent from the lines of other utilities such as railroads and communication companies.

MOVEMENT OF MERCHANDISE BY MONTHS

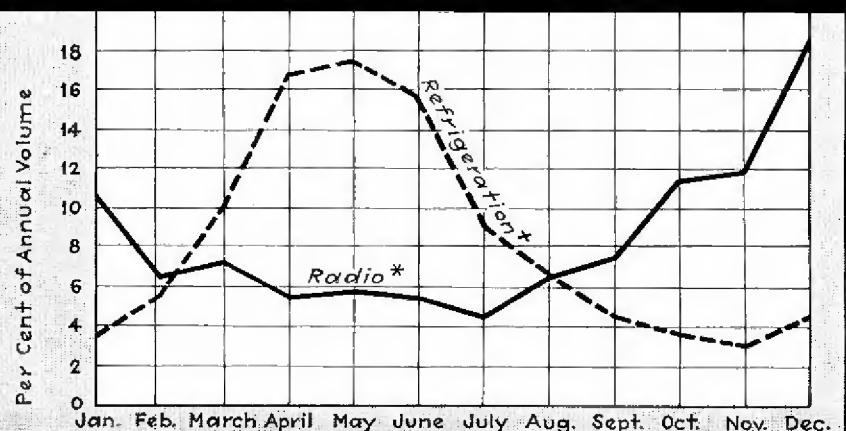

* 1933-1935 Average based on excise tax payments

† 1931-1935 Average prepared from N.E.M.A. and E.E.I. figures

SALESMEN: MEET YOUR

By FRANK

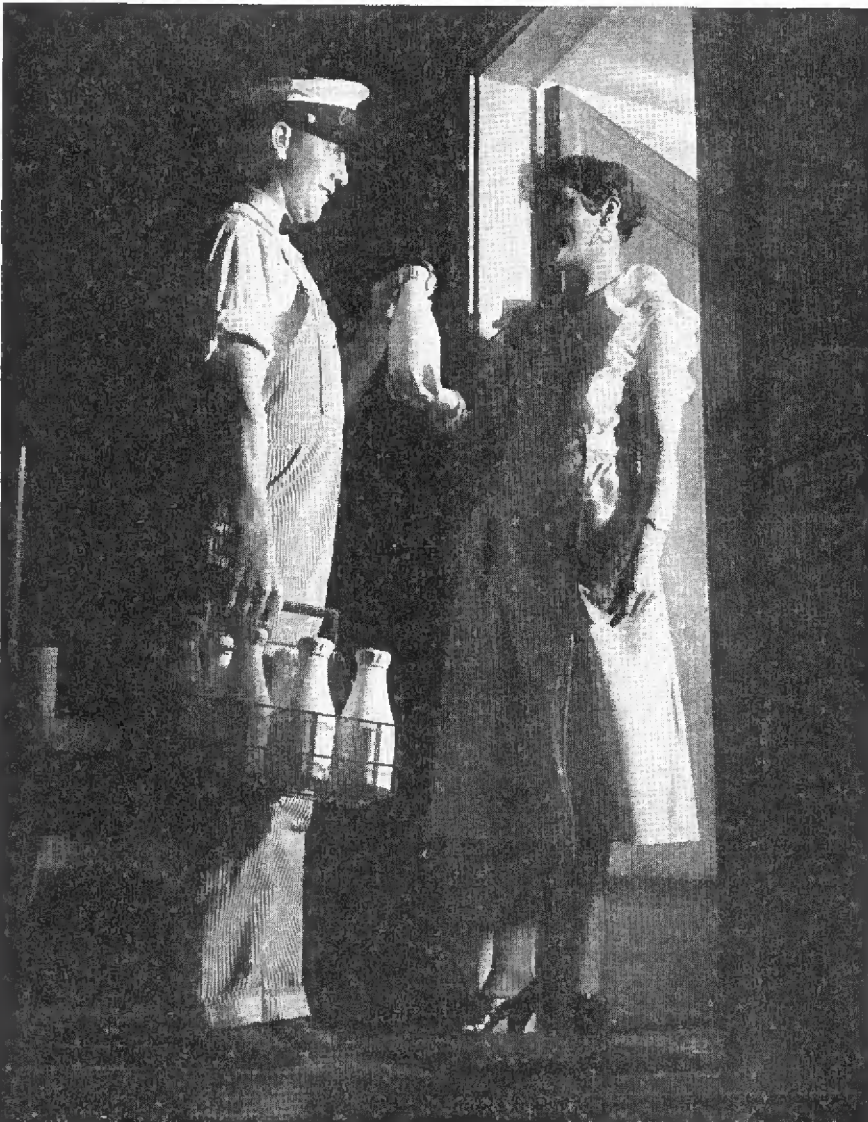

Photos by Galloway, Lazarnick & R.C.A.

The milkman peddles the product, delivers the goods and collects the cash. To hear him talk you'd wonder how the cows can do it for the money. The radio business could use more of the milkman's brand of salesmanship

CONSIDER the lowly milkman. We meet him only as we toddle home at dawn from a night club or something.

He lays down on our doorstep bottles of the delectable and nourishing lacteal at one jitney or *cing centimes* per bot—and we wonder how the cows can do it for the money.

We think of him as a rather inferior grade of delivery boy.

We are wrong.

This milkman is a business man—plus.

He is, first of all, the skilled chauffeur of an atrocious type of automobile which must strut its stuff in fair weather and foul, over ice and sleet, through snowdrifts neck high and around traffic obstructions which would make Cannonball Baker pause.

Next, he is a salesman with 250 to 300 cranky housewives whom he must sell and keep sold. Get those last two words—*keep sold*. If you think that is an easy sales assignment takes a busman's holiday some time and try it. The attendants from the morgue will probably sweep your remains off the back doorstep of customer No. 37—and you'll have to be plenty tough to get that far.



SALESMEN DO AND CLERKS DON'T
... Follow up by telephone

BUSINESS EQUAL

B. RAE, Jr.

He has a route to cover, this milkman, and cover it he must—or else he hasn't any route. Quite a lot different from the route covered by radio salesmen—the route between the blond pluggers of Gershwin's last mess of agony and the redhead who thinks that Ernie Ball is something pitched by Dizzy Dean when the batter gets him three and two.

Well, aside from being a skilled chauffeur and a smart salesman, this milk wagon impresario whom you think is rather a low mug and in no sense your social equal, must also be a collector of coin.

If you think that bill collecting is like passing the plate in the Fourth Presbyterian Church, just go upstairs and talk to the credit manager about it. He will tell you that collecting money is a worse job than pulling teeth from an annoyed hyena and about as profitable as shaving an electric eel. Yet this gentle pastime is an incidental routine part of the milkman's daily task.

He sells the product, delivers the goods and collects the cash.

But that isn't all. Oh, my, no!

He must be a lactic expert with a knowledge of udder stuff which very

few doctors possess. The mothers on his route rely upon him for advice—and, let me emphasize, *dependable* advice—on the feeding of their squalling progeny. Shall it be plain, run-of-the-cow milk or Grade A milk, or milk from those husky bovine matrons of the Island of Guernsey, or from those delicate, gracefully-horned lasses of the Island of Jersey, or shall it be nanny-goat's milk, or—and here is where the milk routeman's face gets red—should the brat be fed at the breast? He's got to know the answer.

At about this point the salesman of radio will ask—and we don't blame him—"What th' hell has all this got to do with the dignified business of selling receiving sets?"

A very great deal.

This milk routeman, whom you look down upon from the Olympian heights of a white collar job, *knows his business*. He is chauffeur, salesman, bill collector, technical adviser—why, dammit, he even salvages the dirty empties and hands out recipes for new ways to use schmearcasse!

And why?

Because he is educated in every detail of his work. He is, I repeat, a



SALESMEN DO AND CLERKS DON'T
... Get the name and address

business man, and that is what we all should be if we hope ever to get anywhere.

In this writer's humble opinion, a great weakness in radio retailing is that so many promising young chaps who have secured positions as floor-men in radio departments are permitted or forced by the house management to become mere clerks. They

(Please turn to page 41)



SALESMEN DO AND CLERKS DON'T
... Talk in terms the customer understands



SALESMEN DO AND CLERKS DON'T
... Tailor their story to fit each type

DISPLAY MANAGEMENT

Experiences from the field, briefed by

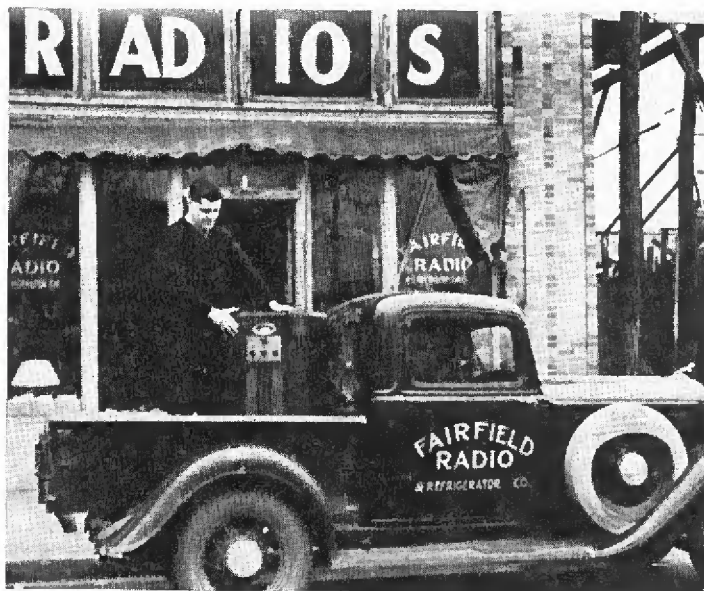

ABOVE . . . Here's a new set on its way to a man who thought all he'd buy was service

UPPER RIGHT . . . Women have bought 43 extra speakers for use in their kitchens in the last three months, at \$4 per throw

LEFT . . . M. W. Cramer, service manager. His peeled eye spots new business in the homes of old customers

Sells Through Service

FAIRFIELD, ALA.—Service, red-headed stepchild of most merchandising operations back in the early days, is fast becoming the very backbone of many set and appliance selling operations. Activity of independents during the dark days of the depression proved that such work need not be done at a loss and dealers have been quick to sit up and take notice. Typical is J. C. McNamee's Fairfield Radio & Refrigerator Company. Says Mac: "Take away my service department and you'd take away my best sales weapon. M. W. Cramer's department is not only standing on its own feet, but his peeled-eye, spotting new busi-

ness when in the home of old customers, is the most effective instrument I have for expanding the business."

Without stepping too far out of character Cramer has sold 43 auxiliary speakers in the last three months to women who want to listen-in while working in their kitchens, storekeepers who live up over their shops and like to have music downstairs. These went for four bucks per throw. Did Cramer service or did Cramer sell? It's hard to tell where one function ceases and the other starts.

Another stunt that puts pennies in the till regularly is the sale of new

chassis to people who call for service on old receivers encased in expensive cabinets. Cramer produces much business of this kind by taking along midget sets of the better type on his service calls, letting the customer play with them while he removes their chassis for a thorough going-over back in the shop. Many sell themselves the idea of trading chassis. Here again . . . where does servicing leave off and selling start?

What does Cramer say to open the doors of old customers? Tells 'em his firm makes a point of checking up regularly, tightens knobs, fixes connection plugs without charge. This is not spare time work. It is his work, just as much as actual repairing. Does it pay? Cramer's efforts among old customers, plus mailing of programs regularly to the old customer list, constitutes the heart of the Fairfield selling plan.

Ad On Wheels

BAD AXE, MICH.—When W. G. Swartz goes afluttering down the country roads of Huron County his truck looks as if it were about to "take off." For, mounted on the hood, is a wind charger, and the pro-

ADVERTISING.....SELLING.....

Radio Retailing's travelling editors

PELLER fairly boils along in the breeze.

That's how Swartz Brothers sold a total of 119 farm sets last year. Operating out of a town of 2,332 population and covering 70 per cent of the county, it naturally follows that the bulk of the Swartz business is rural. Sold only 53 a.c. sets in '35 as a matter of fact.

As evidence of the good business tucked away in highways and byways Swartz offers this breakdown of his battery set sales: Sold 33 models at \$39.95, 64 at \$69.95 and 22 at \$89.95. So successful has been the wind charger on the truck as a rolling advertisement that it has now been adapted to two other cars maintained by the firm.

Lessons For Sales

MILWAUKEE — There's nothing like giving music lessons in the store to sell radios, according to A. H. Knobloch, secretary of the Midwest Radio Company, who has 50 pupils for the accordion, guitar and violin, and turns 15 pupils for sax and bass violin over to his son. Turnover of pupils is rapid and we understand that from 15 to 20 per cent of them are at one time or another accompanied to the store by their parents.

A waiting room (radio demonstration room to you) is maintained for the parents, and Knobloch claims that



If you try this trick make sure the big prop is securely mounted on the old gas-buggy or you'll wind up in a nice, white bed!

the kids frequently insist that their parents stay awhile after lessons to listen to good music. In many instances, parents convinced that their offspring should be able to distinguish between good tone and bad after taking music lessons, are guided in their choice of a set by the youngster of the family.

Pupils become so accustomed to coming to the store that they readily

make themselves at home in the waiting room. This takes away the cold selling atmosphere and many while away hours comparing the tone of various receivers.

"Music lessons have it all over sheet music like a blanket as a store traffic builder," says Knobloch. "So many who buy sheet music simply grab it from the counter, pay their bill and leave immediately."



Knobloch maintains a waiting room for parents of kids who take music lessons at the store, sells radios while they wait

Gimbel's Strategy

PHILADELPHIA — Says Clarence Cashman of Gimbel's, disclosing samples of management strategy that has enabled this store to move an average of 10,000 radios since 1925: "We established a new radio department last spring and identified this section on the store directories and in every radio newspaper advertisement as 'Gimbel's Radio Hall of Fame.' The opening was advertised in four column ads in all Philadelphia papers. Three prominent stars of broadcasting made personal appearances. Miniature self-recorded records were made for youngsters if accompanied

by parents. More than 3,000 log books were distributed on opening day. . . . We featured a contest to find the oldest radio set in service. . . .

"Later we undertook a consistent campaign of twelve ads of uniform size approximating 300 lines each to sell the public the wisdom and pleasure of owning more than one set. This campaign was very successful from the standpoint of sales. . . . Our best efforts are devoted to trying to sell quality at a sensible price, but where reputable stores give us competition on price appeal merchandise we meet it. We undertake to restrict

for this complete
OPERATING DISPLAY
THAT'S ALL YOU NEED TO START SELLING

Admiral AUTO RADIOS

● *And how they sell!* Customers try it . . . customers buy it. See for yourself. Set this operating display in your store for a few days and watch what happens! If you don't find it the most profitable investment you ever made, ship it back and you won't be out a penny.

Admiral sells on Performance

Admiral gives an entirely new slant on tone-quality. The large full size 6 $\frac{3}{8}$ -inch Dynamic Speaker is mounted on a pre-determined "slant" and is not parallel to any of the surfaces of the radio cabinet or chassis. Microphonics and resonance are completely eliminated thereby assuring true perfect tone quality equal to finest home radios. Nothing like it before!

Send for Money-Making Display Today!

Substantially constructed of ply-board with metal props. Attractively finished. Equipped with Admiral 6-tube Auto Radio (\$39.50 list), Twin Speaker (\$6.50 list) and 3 controls—one of which operates the set. Platform for storage battery in back. Your cost complete only \$30—a modest investment that immediately puts you in the auto radio business. Order today from your jobber . . . or from us. Send check or we will ship C.O.D. If you aren't 100% satisfied, return in good condition within 5 days and your money will be promptly refunded.



9 TUBE EFFICIENCY! ... 6 TUBE ECONOMY!

Only Admiral has ALL these outstanding features: Powerful superheterodyne circuit . . .

metal tubes . . . one stage of R.F. preceding first detector . . . rubber mounted 3-gang condenser . . . 175 K.C. double-tuned I.F. transformers . . . 10 K.C. selectivity . . . new R.F. filament and plate filters . . . special vibrator "hash" filter . . . perfected motor noise filter . . . transformer hum eliminated by exclusive double shield diode-transformer . . . easy-to-install single hole mounting . . . mounts in any one of four positions . . . only 1 battery connection . . . only 1 aerial connection.



2 to 7 Times the Antenna Gain!

A newly developed "Series-Fed" Antenna Circuit with iron core antenna coil . . . an exclusive Admiral feature . . . gives 2 to 7 times the antenna gain. Assures extremely low signal-to-noise ratio and daytime reception in any locality. Permits adjustment to roof type, running board or under car aerial.

Jack Provided for Overhead or Rear
TWIN SPEAKER

Continental Radio & Television Corporation

325 W. Huron St., Chicago, Ill.

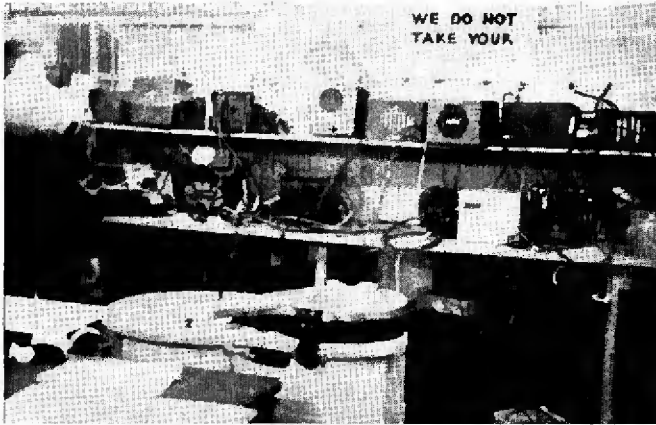

BEFORE . . . Cut Rate Radio Company salesmen (Detroit) had to unravel control cables from a maze of unsightly power wires and speaker leads when the auto-radio demonstration board looked like this

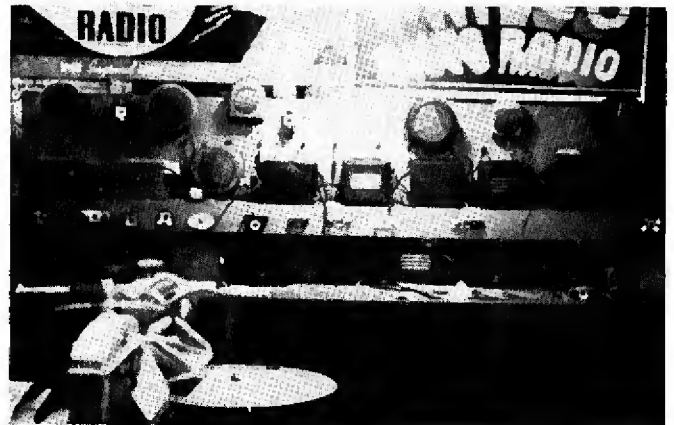

AFTER . . . Mounting of all header speakers on the back-board, insertion of all controls in holes cut in a drop-board nailed to the front edge of the shelf worked this display miracle, aided sales

our number of staple lines by brands to a reasonable minimum. At one time we sold more than twelve different brands; more recently we have cut down to five in the belief that our turnover will be bettered and that we will have less return problems of selling sets a second time and especially because many makers have given us quota incentives to establish a department on a basis of a complete line of model, appeal restricted to a reasonable number of leading brands.

"We have never been able to maintain a good outside selling crew on radio. The mark-up on sets allows only so much for selling cost and we can't maintain a crew of outside men within the limits of allowable selling expense. Of course, we follow up any worthwhile units for which we have a prospect, but not in the strict sense of outside selling enterprise.

"We undertake to support special events held by the store as a whole as our share of the burden. . . . I predict that we will have an exceptionally good year in radio during 1936."

Drive-In Store

DENVER—Farmers who come to town to shop and have difficulty finding a place to park are rapidly discovering that Silver's Auto and Radio Supply Company maintains a 50 by 50 ft. garage directly across the street

from its main display room. They drive in, as many as 50 a day, are exposed to the auxiliary display of home and auto-radios, refrigerators, washers and other merchandise maintained, complete with salesman, at the entrance.

Auto accessory, brake and ignition work pays for the upkeep of this branch. Usefulness of the branch as an auxiliary display only recently dawned on the management. A constantly increasing number of people are now buying appliances here, rather than on the main display floor, and many of them put the stuff right

in the back of their cars, conveniently on hand, and relieve Silver of the necessity for rolling the store's truck.

With the interest in battery radios complete with charging devices on the increase this branch is increasing volume. It's the ideal place to display, demonstrate and sell this class of merchandise, says M. R. Silver, who informs us that battery set business has increased 400 per cent since the drive-in display went into action.

The company's service department has its headquarters here in the converted garage. Swell for rapid pick-up and delivery.



Located directly across the street from the Silver Auto and Radio Supply's main store, this 50 by 50 ft. branch provides room for auxiliary display, accommodates cars for customers while they buy

Thanks a Million!

To All Stewart-Warner
Refrigeration Dealers

**FOR RECOGNIZING THE "HOT LINE" OF 1936
—AND DOUBLING OUR SALES**

*You're giving Mrs. America more for her money—
and smashing sales and profit records doing it*

WE offer our sincere thanks to all you refrigerator dealers whose judgment led you to take on the Stewart-Warner franchise this year. Your fine cooperation in capitalizing this line has enabled us to break all past records, with every month running better than 100% ahead of the same period last year. It's a record we can all be proud of—and one we thank you for helping establish.

To all members of the Stewart-Warner dealer family, we pledge that we'll continue to do all we can to help you go to town with Stewart-Warner—and continue to use this added volume to give you added value in Stewart-Warner products.

The new Stewart-Warner has all it takes to win any housewife. There's SAV-A-STEP, the swinging triple-shelf that turns rear space into get-atable front space. It saves steps, saves current, and gives as much easy-to-reach space as refrigerators costing \$25 to \$50 more. And there's SLID-A-TRAY.

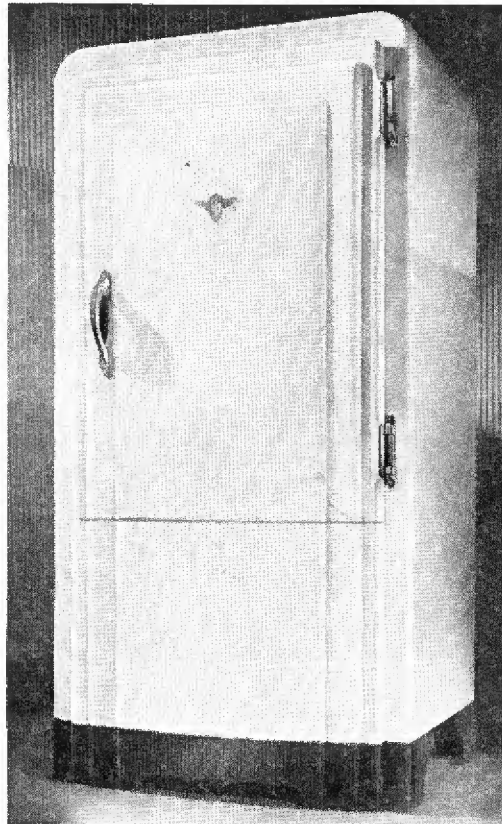

And the current-saving, service-saving Twin-Cylinder Slo-Cycle unit. And the *optional* Stewart-Warner 5-Year Protection Plan. And many others it would pay you to know about.

*The Stewart-Warner 6%
Non-Recourse Plans
Administered by C. I. T.*

In addition to a great product, Stewart-Warner has given you a sales plan of outstanding value. As soon as it became apparent that the F.H.A. finance plan was to be withdrawn, Stewart-Warner dealers were given non-recourse and no-down-payment plans that enabled them to finance their sales expediently through the nationwide C.I.T. organization, whose 144 branches stood immediately ready to serve them.

We have every confidence that with this ideal set-up you will continue to maintain your splendid record throughout the peak months of the season that are still ahead.

Stewart-Warner Corporation
Chicago, Illinois

STEWART WARNER

Page Missing
From Original

(probably a tear-out page)

Page Missing
From Original

(probably a tear-out page)

NEWS

PEOPLE • PRODUCTS • PLANS

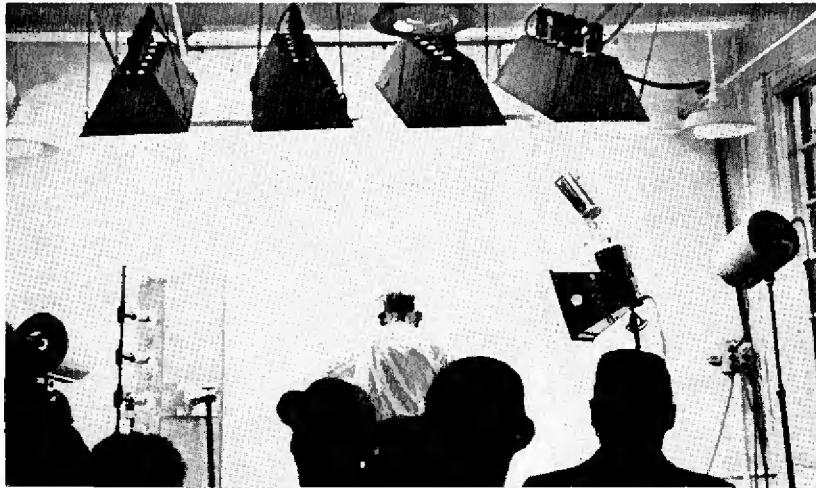

Lighting arrangement, showing bank of twenty-five, 1,000-watt lamps used to illuminate studio subject

SUCCESSFUL TELEVISION DEMONSTRATION AT CAMDEN

Outdoor Fire Scene Received Clearly on 5x7 Inch Screen

CAMDEN, N. J.—Preliminary demonstrations of the latest technical advances in television, conducted by the Radio Corporation of America in its laboratories at Camden, April 24, were well received by an invited group of thirty newspapers and trade press editors. By approximately July 1, RCA will conduct its first field tests of this apparatus in the New York area (RR. April issue).

Reception quality, 5x7 in. screen, while slightly blurred at times, was infinitely better than any tests heretofore witnessed by the writer. Transmission, on a frequency of 46,000 kilocycles, 343 lines, 20 pictures a second, was over a mile radius but, as the transmitter was much smaller than the one to be used atop the Empire State building, results were what might be expected at the fringe of the 17-mile optical range to be tried in New York.

Pictures of an announcer first were picked up by the television camera and flashed on the receiving screens. It was possible to recognize facial features without difficulty. Then a mimic fire was staged by the Camden Fire Department. The television was placed at the window of the studio in the manner of a motion picture

camera and focused on the supposedly burning building about 100 feet from the instrument.

The pictures at the receiving end of the circuit were clear enough to enable the onlooker to see apparatus being hauled to the roof by a small rope. Cars could be seen on a bridge more than 1,000 feet away.

The unit contains two receiving sets: one for sight and one for sound. The picture is reproduced on the fluorescent screen of a cathode-ray tube which is mounted vertically in the set. A mirror on the top of the set is adjusted to about a forty-five-degree angle to make it possible to view the picture from in front of the receiver.

The set itself has fourteen controls providing for adjustment of both the picture and the sound. A tuning control in the center tunes both the sight and sound receivers. When the sound is turned in, the picture is automatically available. Other controls adjust the aural volume, tone, fidelity, contrast in the picture, detail, brightness, framing and synchronization. Thirty-three vacuum tubes in all are employed in the set, including the large cathode ray valve.

Estimated retail prices for present type of dual receiver—when and if, but not sooner than 1938—from \$300 to \$700.

CASE RADIO CO. AND HALLICRAFTERS MERGE

CHICAGO—Case-Hallcrafters Corporation is the name of radio's newest company, organized here last month to manufacture home and communication receivers. This concern is the result of a merger, April 13, of Hallcrafters, Inc., this city, and the Case Radio Company, of Marion, Indiana. The former concern was founded by W. J. Halligan—who will be president and general manager of Case-Hallcrafters.

Headquarters will be in Marion, where the extensive plant of the Case company assures ideal manufacturing conditions.

Arthur E. Case, former president of Case Radio, will be treasurer of the merged units. Other officers: S. J. Thompson, formerly of the radio division of Montgomery Ward & Co., vice-president; Robert Durcette, vice-president, and George Maselik, secretary.

Smoke-Eaters Oblige



Camden's fire department staged this scene for television pick-up. When shown on receiver, even the rope from roof to ground was recognizable

GENERAL MOTORS WILL MAKE ITS OWN AUTO RADIO SETS

DETROIT—Purchase of the Kokomo, Ind., plant of the Crosley Radio Corp. by General Motors, effective May first, is by no means an indication that the former is withdrawing from the auto-radio field. Quite the contrary is the case, according to president Powel Crosley, Jr., who states that the functions of the Kokomo factory will be intensified in the expanded floor space recently provided in Cincinnati. It is also expected that G.M.C. will continue to buy from its former a-r suppliers, Crosley, General Household, RCA and Colonial.

By this purchase, General Motors becomes the first automobile maker to undertake to produce, in part, its own factory made line of motor car receivers. It will be recalled that G.M.C. took a flier in household sets three years ago at its Dayton, Ohio, plant but withdrew from that venture.

GRUNOW REORGANIZATION PLAN APPROVED

CHICAGO—Judge Phillip Sullivan, in the District Court of the United States here April 17, approved the reorganization plan of the General Household Utilities Company. General Household (Grunow radios and refrigerators) has operated at a profit during a difficult period, states the company's letter announcing this decision. A note of appreciation to its many dealers, distributors and suppliers, "who have contributed so much to our success," is extended in this communication.

As of March 31, the pro-forma balance sheet discloses current assets of \$2,302,744 and current and deferred liabilities of \$1,252,924. This statement does not include an additional \$400,000 from the Reconstruction Finance Corporation to be used as a revolving fund during the company's active season.

Friendly Rivalry



Max Haas (left) of Bud Radio and M. Lertzman of ICA wondering who will be the first to make what

RMA Trade Practice Rules Due for FTC Decision in June

WASHINGTON, D. C.—Now under advisement by the Federal Trade Commission, present indications are that a decision on the RMA Trade Practices hearing will be rendered next month. Because of the favorable reception accorded RMA's suggestions by the FTC at the April 7 hearing, it is felt that the findings will be favorable.

The proposed trade practice rules for the set manufacturers cover the matters of misleading claims, correct terminologies in describing the kind and number of wave bands employed, commercial bribery, imitation of trade marks and false branding.

Comfort On The Job



Howard Sams (sans coat) and Gordon Peck of Mallory face the cold, merciless eye of our candid camera in the plant at Indianapolis.

RMA Convention

CHICAGO—Reversing the order of prior years, the Twelfth Annual Convention of the Radio Manufacturers Association will open with the Industry Golf Tournament. This affair will be run off at the Calumet Country Club, Wednesday, June 17.

Committee meetings start the following day, preceded, at 10 a.m., by a meeting of the Board of Directors. At 12:30 there will be a membership luncheon, president Muter presiding. Thursday night is the RMA Cabaret Dinner for members and guests. Friday, June 19, has been scheduled for the annual meeting of all RMA members, to be followed by a luncheon for the new Board and the election of officers.

All events will be held at the Stevens Hotel, Chicago.

JOBBER NEWS

R. B. WALL CO., Wilkes-Barre, has signed with Atwater Kent for Pennsylvania territory.

ALLIED RADIO CORP., Chicago parts house, is the latest addition to Ken-Rad's growing list of tube distributors.

ARNOLD SINAI, San Francisco, and NORTHWESTERN AGENCIES, Seattle, will cover their respective territories for the Atlas Sound Corporation, of Brooklyn, N. Y.

MAC-ADAMS EQUIPMENT CO., New York City, states that it has just completed arrangements to distribute General Electric auto sets in the Metropolitan area.

Recent additions to Stromberg-Carlson's impressive roster of jobbers are the following well known firms: EDWARDS AND WALKER, Portland, Maine; GRAYBAR ELECTRIC, for northern and eastern Texas and six counties in Louisiana, and GRAYBAR ELECTRIC, of St. Louis.

TIMES APPLIANCE CO., INC., one of the oldest and largest electrical houses in the East, now is the exclusive distributor for Fada in the Greater New York area. This important appointment comes as the result of well considered negotiations between J. M. Marks, general manager for Fada, and Messrs. E. B. Ingraham and Oscar W. Ray, representing Times Appliance.

Shortwave Research

CAMDEN, N. J.—Research work conducted by the Radio Corporation of America has revealed the potentialities in the intermediate field of short waves of 20 to 60 meters, and now is indicating vast possibilities in the field of ultra-short waves below 10 meters, where television and facsimile may find their greatest practicability and value. Nor has the laboratory stopped there. There is promise of usefulness for centimeter waves below even one meter. These may open up entirely new services.

Average Wind Velocities Throughout the United States

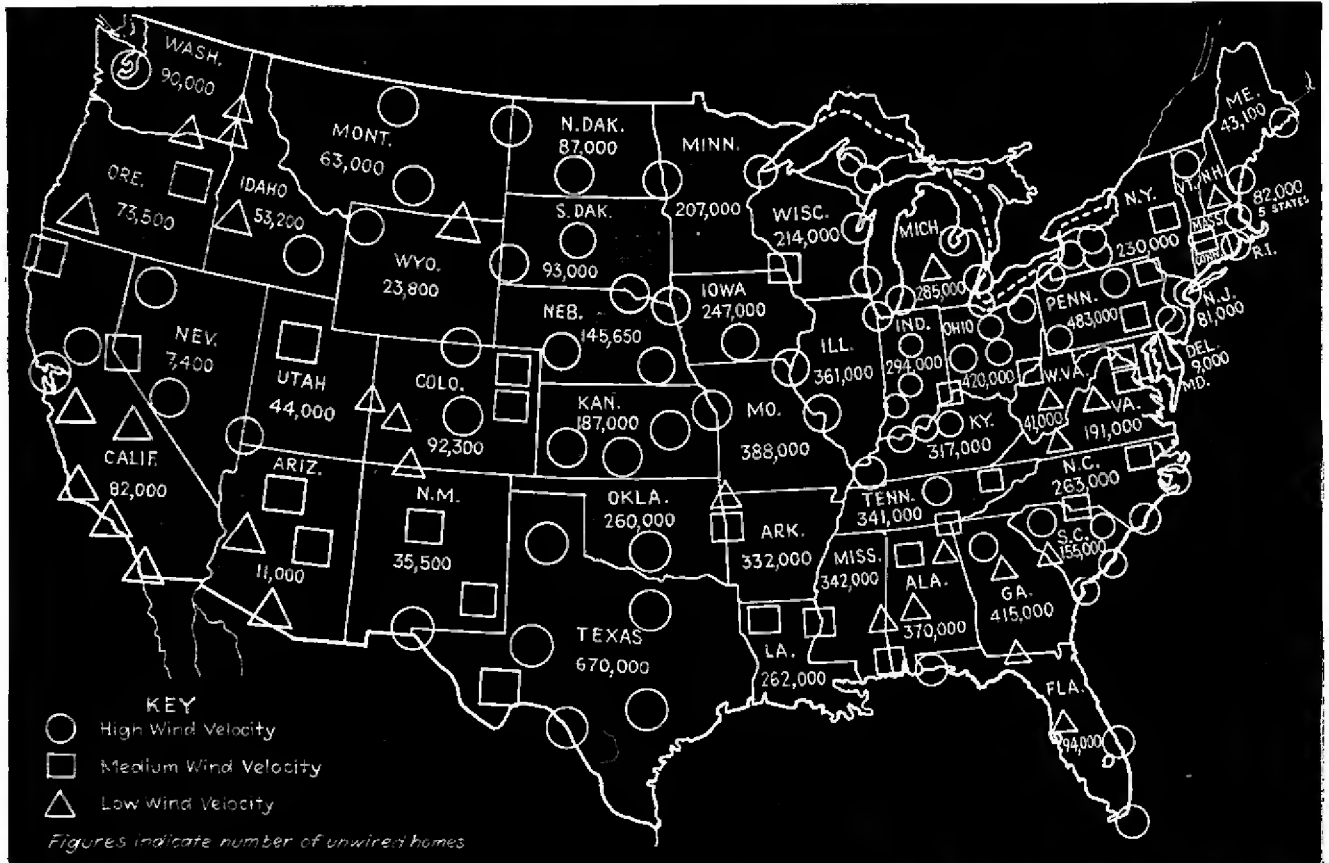

Many Areas Suitable for Wind Driven Power Plants

The above map shows the average wind velocity in all parts of the United States. It is based on Government records maintained over a period of 35 years and has been used for sales purposes with excellent results by the Wincharger Corporation, Sioux City, Iowa.

In high wind areas—minimum eight miles per hour (circle)—a small size charger will, as a rule, generate sufficient current to operate a radio set throughout the year. Results can be guaranteed if an eleven mile wind is the prevailing flow.

For medium wind velocities (denoted by a square) install the larger unit. Even in low velocity sections of the country a "de luxe" charger will keep the battery in operative condition most of the time—necessitating but two or three additional line charges a year.

8,466,000 Unwired Homes

Note that this map also gives the number of unwired homes by states. These total 8,466,000 for the entire country—a vast and unsaturated market now largely salable due to recent developments in low cost power supply independent plants.

When, to this service, is added American shortwave programs—see map of poor reception areas and sw article elsewhere in this issue—your battery set story now adds up to 100 per cent.

Over 500 GE Dealers Enjoy West Indies Cruise

NEW YORK—May 2, over 500 General Electric dealers, wives and friends left this port on a 12-day Caribbean cruise. Director D. W. May, radio sales manager, New York division, planned a trip which included not only South American and West Indian calls but the Panama Canal, with a glimpse of the Pacific Ocean thrown in for good measure.

This reward for aggressive selling was the second family cruise by GE.

The first husband and wife affair, down the St. Lawrence last fall, proved such an overwhelming success that this present and elaborate affair just had to be. Will be pictorially reported next month.

Will Circularize 50 Prospects

SIoux CITY, IOWA—A new sales plan to aid dealers in selling more farm sets is announced by the Wincharger Corporation, this city. This concern will send fifty prospects an illustrated folder showing the advantages of wind-powered charging units and describing the plan by which a generator may be obtained for \$15.

Dealers may obtain this service by ordering one DeLuxe Wincharger for display purposes and sending in the names of fifty prospects to the factory.



These radio equipped buses are business builders. Detroit passengers now wait for the bus with incidental music and complain if they have to take one without it.

KSTP Enlists Other Stations in Campaign To Improve Reception in the Home

Wide Range Transcriptions Used in Programs Aimed at Poor Receivers

MINNEAPOLIS—Aiming its guns on the faulty receiving set, which it terms radio's great obstacle to better reception, KSTP, Minneapolis and St. Paul, has enlisted the aid of other major stations throughout the country in a campaign to make listeners conscious of reception quality. A series of broadcasts, known as "Getting the Most Out of Your Radio," demonstrate the shortcomings of the ordinary receiving set.

KSTP, a subscriber to World Program Service, is using its Wide Range transcriptions in an attempt to help radio advertisers, listeners and the stations themselves in capitalizing to the fullest extent on the millions poured annually into fine talent and broadcasting equipment. By cutting off certain frequencies and asking the listener to observe the effect, KSTP is planting the seed of doubt in his mind—doubt that perhaps his set is not bringing him all the pleasure and enjoyment that it should.

One of the first programs pointed out

that if the listener noticed no difference when certain frequencies were cut off, then his set was not functioning properly.

Similar to WOR Test

A similar program has been tested by WOR, New York, and the entire campaign of educating both advertisers and listeners to the value of Wide Range quality is closely in line with work constantly carried on by World, whose vertical cut transcriptions illustrate the KSTP series.

WBIG, Greensboro, N. C., Runs "Better Reception" Programs

GREENSBORO, N. C.—Another far-seeing broadcaster is WBIG, who promotes programs and their better reception in a daily "Radio Spotlight" review, contributes this specimen announcement. After pointing out the wonderful programs "you get absolutely free" the announcer concludes:

"Never before in history have the broadcasters spent such huge sums to entertain the radio public. Sponsors are spending millions to fill the air with the finest programs ever presented. If you haven't a radio, visit your nearest dealer and let him explain how easy it is to own the very latest achievement in the world of radio research."

Greensboro dealers report that these gratis announcements have brought many prospects to their stores for the higher priced models.



The many friends of Ben Erskine, pres. Hygrade Sylvania, will welcome the news that Ben is on the job again. Right—Hall Stackpole, of Stackpole Carbon Company, St. Mary's, Pa.

Stern & Co. Granted Greater Territory for Grunow Line

HARTFORD, CONN.—Francis Stern, well known New England wholesaler, has taken over the states of New Hampshire and Rhode Island for the entire radio and refrigerator line of the General Household Utilities Company, Chicago. Stern & Company formerly represented Grunow in Connecticut, Vermont and western Massachusetts, which territory it will, of course, retain.

"Representatives" Meet

CHICAGO—Half a hundred sales representatives for the parts makers held a meeting here last month to discuss mutual problems. Perry Saitler, New York, presided in the absence of President Jack Price.

Station "Top Hat"



George Hicks, NBC announcer, is shown wired for sound. Hicks' cutaway hides a wide leather belt containing the power plant. In his silk hat is a new type micro-wave transmitter. The aluminum rod sticking from the topper is the antenna. Station "Top Hat" operates on a frequency of 270,000,000 cycles; power, two-tenths of a watt; range, one-quarter of a mile. A mobile unit picks up the program and relays it to Radio City—hence out over a national network.

Six San Antonio Servicemen Get Free Air Time

Local Station KTSA Cooperates to Keep Its Listeners' Sets in Prime Condition

SAN ANTONIO, TEXAS—Some time ago Jake Jaquier, manager Southwest Broadcasting Company instituted a little plan from which he has built considerable good will for his station, and also benefited the set dealer and serviceman. Realizing that a great many radio sets are mechanically inefficient due to "wear and tear," he made an agreement with six dealers and servicemen, to make service calls on set owners that were not receiving the best in reception. Daily several announcements were made to the effect that if programs are not satisfactorily received at any time of the day or night, or if listeners are experiencing any difficulty with their sets, a call to our station will bring a responsible serviceman for a free inspection and minor adjustments. In the event major repairs are necessary, the serviceman will

leave an estimate of such essential repairs—the set owner being under no obligation to have these repairs made.

The station's agreement with these six dealers was that any minor adjustment would be made at the time of the first service call—no charge. In the event the set owner needed larger repairs these would be made at a reasonable cost.

In return for the service performed by these servicemen, KTSA gives them individual spot announcements covering their service generally.

This plan has worked quite satisfactorily and KTSA has been complimented many times. In return the servicemen have been more than repaid in the additional revenue as a direct result of this service offer to listeners.

Editor's Note: A mighty fine idea and one that should be worked in every community. Why not put this plan up to your local station manager? You'll find him an attentive listener.

Distributors in the News



M. J. LEWIS—president, Lewis & Carnell, Philadelphia. His "President's Month" netted top volumes sales for American Bosch



MORTY SALTZMAN—back from Florida, he's pushing Stewart-Warner in New York. Heads Wholesale Radio Equipment Co.



CHARLES REYNOLDS—Binghamton's (N. Y.) radio pioneer, parts maker, service specialist, jobber and now Norge and RCA representative



LESTER LATHAM—another fisherman extraordinary. At his New York desk Les engineers the eastern destinies of Kadette



D. R. BITTAN—this cruise-minded gent is eastern representative for American Microphone Co., Los Angeles, Calif.



HERB HIEB—strong contender for a profit margin on battery set accessories. Headquarters in Des Moines, Iowa

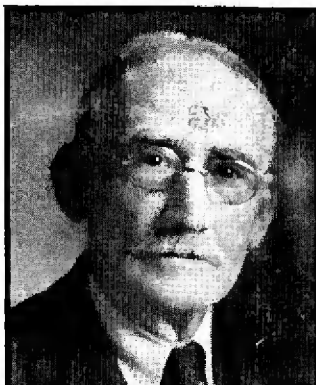

FREDERICK WALKER—86 years old and on the job every day. A founder of Edwards & Walker, Portland, Maine



BOB CLARK—First distributor for Stromberg-Carlson and still going strong in Denver and Rocky Mountain territory



HOWARD RICHARDSON—formerly Crosley SM, now v.p. of Taylor Electric Co., Milwaukee, RCA and Leonard lines

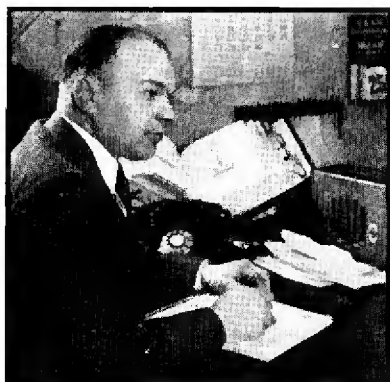

H. M. LONG—radio division sales manager for Southern Tier Electric Supply Co., Binghamton, N. Y., General Electric jobber



NATE REIFLER—directs radio sales for Electra Supply Company, Poughkeepsie, N. Y.



D. T. LANSING—Heads firm of same name and roots for Stewart-Warner in Scranton, Pa.

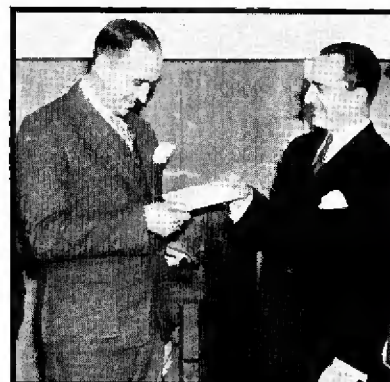

NICK YOUNG—of Hatry & Young, Hartford, Conn., on receiving end of \$100 cash award in GE "Ad Manager" contests



Sound

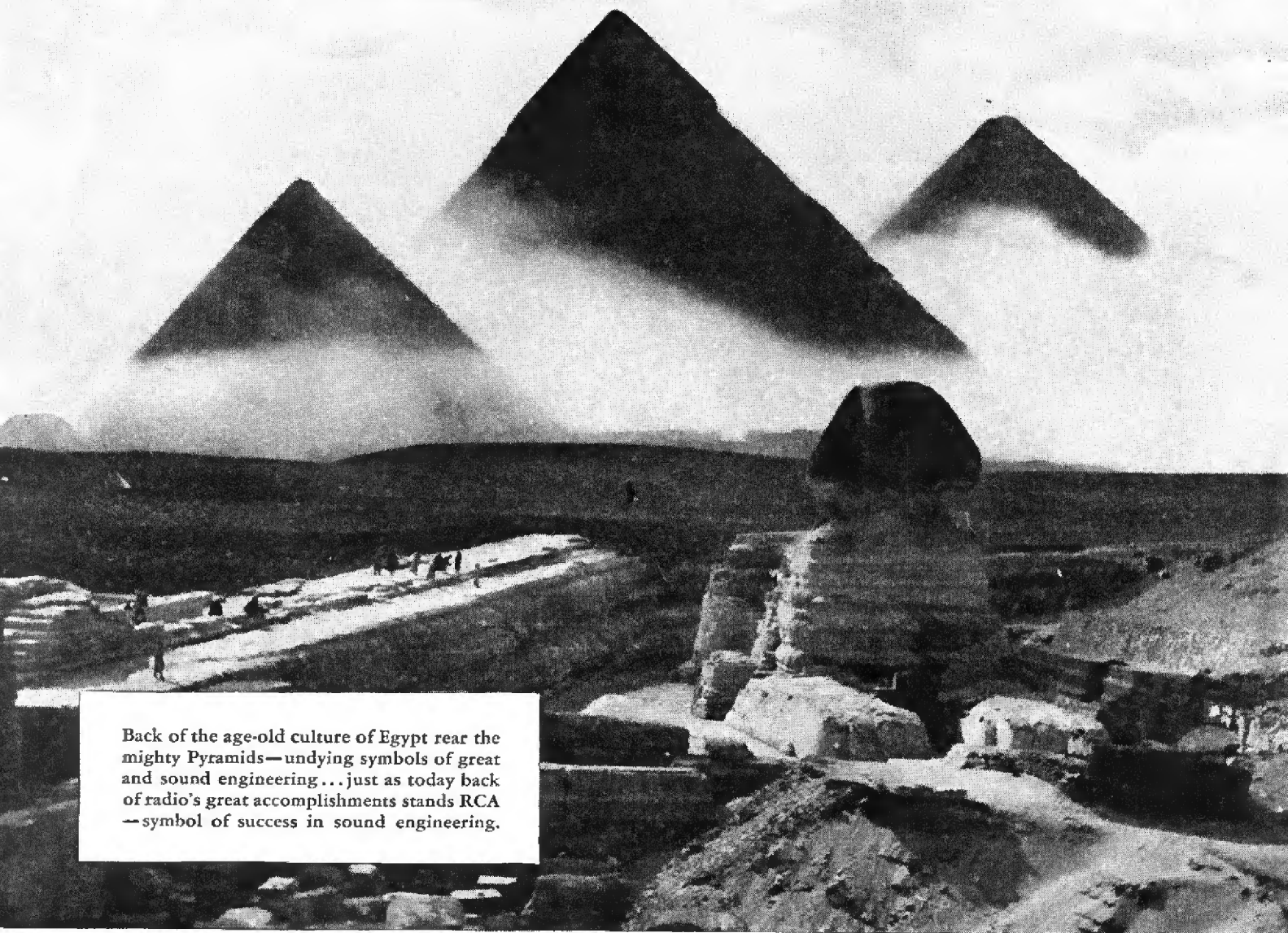

Back of the age-old culture of Egypt rear the mighty Pyramids—undying symbols of great and sound engineering... just as today back of radio's great accomplishments stands RCA —symbol of success in sound engineering.

RADIO CORPORATION OF AM

Engineering

The Three Pyramids of Radio...

COMMUNICATIONS... BROADCASTING... RECEPTION

all engineered by RCA

LIKE links in a mighty chain, RCA joins the entire world in a series of International, Domestic and Marine *Communications* systems . . . sending and receiving messages via Radiomarine from ship-to-ship and ship-to-shore—messages "Via RCA" Communications to 47 foreign countries and all leading cities in the United States!

Broadcasting is another phase of radio in which RCA is active, serving the public and advertisers with varied programs on 88 powerful stations . . . associated with the National Broadcasting Company.

In *Reception*, RCA leads the way, manufacturing radio receiving sets for city, farm and automobile use, as well as transmitters, tubes and

specialized equipment for all purposes—all made in plants of the RCA Manufacturing Company. Not only does the Radio Corporation of America serve the world with these varied activities, but through RCA RESEARCH LABORATORIES it *has* given a long list of radio "firsts" that are harbingers of all that is still to come. Some day, RCA will engineer *sight!*

The nation's buying public is conscious of the fact that RCA knows radio. Hence it has *confidence* in anything bearing the RCA trademark. Confidence make sales. That's why RCA dealers do a better business—enjoy greater profits. They are allied with RCA—the only organization engaged in every phase of radio—and Radio's Leader!

Listen to "The Magic Key of RCA" on WJZ and associated NBC stations every Sunday, 2:00 to 3:00 P. M., E. D. S. T.

AMERICA • *Radio City* • NEW YORK

WHAT A MARVELOUS NEW
WAY TO TUNE A RADIO!
I HEAR A FAMOUS DESIGNER
DID THE NEW CABINETS



THAT'S HOW A RADIO
OUGHT TO SOUND!
SAY, THAT NEW DIAL
IS A BEAUTY!
THAT'S THE RADIO
I'VE BEEN LOOKING FOR!

Coming!

WORLD PREMIERE

of the new 1937

ATWATER KENT

the line that will

GET THE EYE • GET THE EAR • GET THE SALE

NEW HAMPSHIRE CONCERN GETS PAGE PUBLICITY

**Radio Service Laboratory Opens News
Headquarters with Much Fanfare**

MANCHESTER, N. H.—“Six years ago two young men with an idea started a one room radio repair shop in this city. Reynolds W. Smith and Arthur A. Levesque were the two fellows and they now head the largest firm of its kind in New England.”

The above is from a write-up in *The Union*, Manchester, N. H., newspaper; just a small part of a full page of advertising and publicity which their outfit, Radio Service Laboratory, put over marking its expansion into larger quarters.

Smith and Levesque sold the idea of ad tie-ins to practically every parts manufacturer doing business with them. These paid advertisements, and their own center display announcement of an Open House Party, carried the three columns of free editorial write-up material.

Some of the heads on the news items: “Drive-In Service For Auto Radios,” “Stock Room Full of Wanted Parts,” “Laboratory Mecca of Amateurs,” “Live Organization Known to Many,” “One Room Shop Grows to Largest Service columns of free editorial write-ups.

We Had One Too



Art Moss of Electrad, across the table in Chicago's Hotel Sherman grille.

Connelly Holds 12 Meetings

SEATTLE—The F. B. Connelly Co., of Seattle, Portland and Spokane, has just completed its introduction of the Grunow new models refrigerators to more than 400 dealers in Washington and Oregon. Twelve sectional meetings were held. They proved of greater value than the larger get-togethers.

Los Angeles, Cal.—American Microphone Co. has been granted a license by the Brush Development Co. which will permit the former to manufacture crystal microphones under Brush patents.

Letters

We Always Have

I want to congratulate you on the current (March) issue of *Radio Retailing*—and the splendid way in which you are tying up current radio programs with the impulse to buy new radios, all to the dealer's welfare.

I think there is a basic job to be done helping the dealer sell more radios by getting him to educate his prospect to the endless, rich variety of programs now available at the turn of a dial.

And I think you are helping a good deal to get this job done.

New York VICTOR M. RATNER
Columbia Broadcasting System

Small, But Numerous

I am writing my answer to your article of the March issue “What's Wrong With the Combination.”

It is my opinion that the large volume of sales of radios is made by the many small dealers and as the record setup is such that the small dealer cannot afford to stock records he, therefore, does not feel that he should push the sale of the combination as it is almost impossible to do so without stocking records.

Van Nuys, Calif. E. R. WEBBER

Net Price Nitwits

I have just read Harry T. Schmidt's letter in *Radio Retailing* (March) and agree with him 100 per cent as I just had a case like his this week and am plenty disgusted as every catalog I have received lately contains net prices.

My suggestion is to have such catalogs printed with all the auto-radio, home radio and amplifiers marked with list prices. It don't matter so much about the smaller items but mikes, phono-pickups, motors, etc., should be marked list.

I hope radio jobbers think this over as they would profit as much as we would. Middletown, Pa. CHARLES H. HOOVER

Good Solution

I agree with H. T. Schmidt, of Indiana, only I would go a step farther and suggest that some of these jobbers cut out advertising merchandise at very low prices which they do not have in stock and cannot supply at all.

We get a catalog through the mail and look through it. What bargains! We sit us down and send through an order for three or four dollars worth of stuff and receive from one-third to one-half of it. Just sucker-bait, those ads, to sell a few items that they have or can get.

I've been stung plenty so now I always

tell them to ship every item as ordered and not to substitute and not to ship any if they can not ship it all. And C.O.D. Holliston, Mass. BRUCE L. COREY

It's Mutually Profitable

We have read with a great deal of interest your current issue and compliment you on the editorial in which you state that radio dealers and broadcasters should cooperate more fully.

We have a program of fifteen minutes at 11 a.m. each day in which we announce the feature programs and we frequently stress the point that listeners should have their radios overhauled and put in good shape if they are old type, et cetera.

We read much about contact at point of sale, cards, displays. In the principal dealer's display rooms we placed frames of photographs of both Columbia and local program artists. We talked to salesmen and told them of the programs coming. Salesmen for the leading dealers have caught the idea and are selling programs with radios.

We believe that every dealer and serviceman should be furnished, by either the networks or individual stations, with cards, booklets and other advertising matter to be presented to each purchaser of a new radio, something to tie new receiving sets directly in with the nearest, best station. Greensboro, N. C. EDNEY RIDGE
Radio Station WBIG

Des Moines SOS

I am interested in your March editorial—“The Need is Mutual”—and wonder if anything can be done to bring about closer cooperation between broadcasters and the radio trade here.

In the early days, you will recall the remarkable cooperation between the Northwest Radio Trade Association and the Twin City broadcasting stations. Everyone worked together for the advancement of radio.

At the present time, broadcasters and the radio trade attend strictly to their own business and do not seem to have any common interests. Radio dealers and servicemen can help us by making reports on quality of reception and popularity of various program features. We can help dealers and servicemen by informing the listener that most radio sets do need new tubes, better aerials and, most important of all, that every home needs a modern set to really enjoy radio to the fullest extent.

If you have any ideas on an experimental plan we will try to work them out.

Des Moines, Iowa J. O. MALAND
Radio Station WHO



Members, wives and friends of the Cleveland Chapter, Institute of Radio Service Men leave for Chicago on B & O special. Eighty-three representatives attended the recent IRSM convention

Chicago Dealers Continue Price Protection

Based on "Authorized Dealer" Plan

CHICAGO—Putting it squarely up to the jobbers, the Illinois Radio & Electrical Dealers Association, last month, requested that the former group authorize price-maintaining merchants and refuse to sell the other type.

In a letter to all northern Illinois distributors, Executive Secretary George Rockwood outlined the objectives of his organization as follows:

1. Protect the authorized dealer in radios and refrigerators.
2. Curtail the price-cutting of such products by unauthorized, unethical dealers and sub-jobbers also catalog houses doing an industrial business.
3. Educate the public to buy at the suggested retail price and through the legitimate dealer.

The jobber was requested to display and advertise the following:

"Warning—Purchase your radio only from an authorized Blank dealer. Otherwise, the Blank guarantee (here state factory guarantee) is null and void. Look for our label of authority. This is your protection to insure proper service."

Also asked to supply the retailer with a sign (loaned during good behavior period) which would proclaim the fact that Dealer Jones was authorized as a recognized store to sell the BLANK line of merchandise. Also a large floor sign plainly listing the retail value of each model of radio and refrigerator carried.

This latter plan already has been worked out by the Maytag Company and is in successful operation.

MANAGERSHIPS

GEORGE SAMMIS becomes divisional sales manager in charge of Wisconsin, northern Illinois and Indiana for Atwater Kent. Formerly with Sunset Electric Company, Portland, Oregon.

E. H. SEVERSON is the sixth divisional sales manager to be added to the A-K staff since January. "Ernie" has the southern district which includes Arkansas, Mississippi, Louisiana and Texas.

DANIEL BAUMBAUGH succeeds Rolla Burke as manager of the Cleveland store of Rudolph Wurlitzer. Baumbaugh comes to his new connection from the May Company, Cleveland.

RAY W. AUGUSTINE, formerly with Utah, Chicago, is midwest DSM for the Cimaudagraph Corporation.

Powel Crosley, III, Honored

CINCINNATI—Powel Crosley, III, has been elected a vice-president of the Crosley Radio Corp., by its board of directors, states Powel Crosley, Jr.

Bond Bought by Winchester

NEW HAVEN, CONN.—The battery business of the Bond Electric Corporation, Jersey City, N. J., has been purchased by the Winchester Repeating Arms Company, this city. Sale includes the goodwill, patents, merchandise and machinery. Bond formerly manufactured radio tubes under its own name brand.

Official Service Laboratory

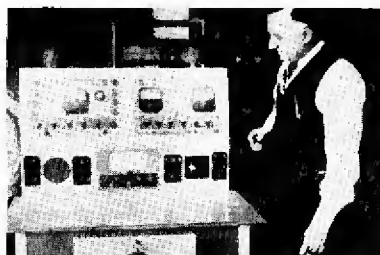

RR's cameraman shoots the first production model of Earl Webber's new "Official Radio Service Laboratory." It's to be on wheels.

Detector

With one accord the big outlets complain that the jobbers are appointing too many dealers per given trading area. It's the little fellows that cut the prices, with excessive trade-in allowances, and upset the apple cart, they claim.

We found the department stores in southern New York state and northern Pennsylvania (last month's trip) particularly vehement—so much so that many are considering laying off standard brands to push again their own trade-marked merchandise.

The growing popularity of 6-volt chargers of both the gas and wind-driven varieties suggests a need for low-voltage, low-drain d.c. motors capable of operating kitchen-mixers, fans and other small appliances that farmers and their families must now do without.

A very large tube maker has tooled up in a big way to supply "G" type tubes for the replacement market. And a very large set maker plans to catalog "G" tubes—also for replacement sales.

What, with the acceptance by the trade and public of these new octal based, glass envelope tubes in new sets . . . well, 2 and 2 equal 4.

Sales value of the metal tube still a debated subject. Opinion about evenly divided for and against, the stand patters claiming that a receiver is just as saleable with a full complement of glass tubes.

"Service calls made to satisfy the recent purchaser of a new set, under guarantee agreement, should be charged to sales promotion. It's unfair to shoulder the service department with this unmerited expense," Ross Baxter, Broome Distributing Co., Binghamton, N. Y.

"We sell on time and charge ten per cent over list for this accommodation. The customer, therefore, is entitled to special consideration. That's why we cheerfully answer all calls to 'look at my set'—and charge this type of service expense to the sales department." Scranton Talking Machine Co., Scranton, Pa.

Blessed be the set maker with backbone enough to inaugurate a real franchise policy—Bill Seemuth.

Webster's (Racine) ad man objected to our use of the words "Public Address" in a recent conversation, suggested that "Sound Equipment" was much more inclusive. We think he's right. P. A. does create the vision of a large open-air pavilion hung all over with speakers so we're dropping the term. Those two letters were convenient for publishers, however, and we'll miss 'em.

The March of Tubes!



From Set Manufacturers to the Homes of America . . .

AS TIME MARCHES ON — Raytheon's momentum increases and it will be further accelerated by Raytheon's new line of "G" tubes.* Thousands of new sets will be equipped with Raytheon "G" tubes, paving the way for more Raytheon replacement sales.

Leading set manufacturers prefer Raytheon quality and performance, Raytheon's painstaking attention to details, Raytheon's research and production engineers. That's why Raytheon is the fastest growing tube producer today.

Raytheon dealers and servicemen are capitalizing this

established, ever growing replacement market.

A COMPLETE LINE—"G" types, standard glass and Genuine All-Metal types. New technical information now available. Write for it.

RAYTHEON PRODUCTION CORPORATION

420 Lexington Ave. New York City
55 Chapel St. Newton, Mass.
445 Lake Shore Drive Chicago, Ill.

555 Howard Street San Francisco, Cal.
415 Peachtree St. N. E. Atlanta, Ga.

RAYTHEON
TRADE-MARK
4-PILLAR RADIO TUBES

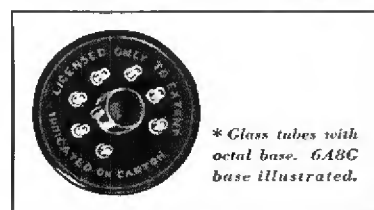

* Glass tubes with octal base. 6A8G base illustrated.

SHORTWAVES

Next month the political conventions will be going full blast. For the most part, the sessions will be held during daylight hours—and so reported over the air. And the farmer, whose listening habits favor noontime and early evening dialings, will compose a big part of this audience. Here's where American shortwave tuning for Americans should be merchandised—for many of these dialers are in poor reception areas.

April 1, W2XAD increased its daily schedule by three hours. Now goes on the air at 10 a.m. and operates till 3 p.m.

Radio Guide asked its readers whether or not they were in favor of the continuation of its short wave columns and comments. The results were so overwhelming that they wiped out all doubts that the editorial department had. The almost unanimous decision was: "Give us more news about short waves."

Dealers who want a lot of shortwave news should get on the mailing list for GE's "Short-Wave News" sheet. Write the General Electric Company, Merchandise Department, Bridgeport, Conn.

Because most programs broadcast by PHI, Eindhoven, Holland, 11.73 meg., are so early in the morning, American time, that few listeners hear them, the Netherlands stations recently began a special Sunday program directed toward the United States and the North American continent, from 7:00 to 8:00 p.m. EST.

Hitler's ultimatum to the world was carried by shortwave with a speed of 186,000 miles per second. Listeners in the United States actually heard the speech before the words reached the Reichstag members seated in the last rows of Kröll's Opera House, Berlin.

Shortwave radio is revolutionizing European diplomacy these days. The governments of England, France, Germany and Italy led each other a lively chase last month in a race to be the first to tell the world their versions of each day's developments.

Two New Booklets

"Yardsticks," a new 2 color folder issued by the Ohio Carbon Co., 12508 Berea Rd., Lakewood, Ohio, gives specifications, test data and prices of "Ohiohm" carbon resistors; also details on Ohiohm assortment kits for servicemen.

An exclusive arrangement has been consummated by Arcturus Radio Tube Co., Newark, N. J., for a baseball schedule giving the playing dates of the teams in the American and National Leagues. Other interesting and valuable baseball information is also given. Attractively printed as an 8-page folder. Available, with imprint, through Arcturus distributors at a nominal cost.

Tour Conductor

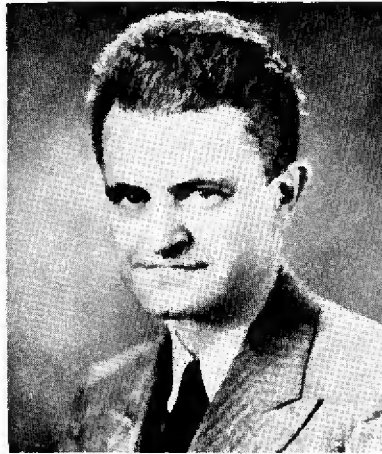

John Erwood, v.p., the Webster Co., ran a sound equipment meeting followed by a tour of Chicago factory for Webster representatives last month.

New Crosley Lines

CINCINNATI—The 1937 line of Crosley radios was enthusiastically acclaimed here last week by 150 officials of the distributors of the Crosley Radio Corporation. The popular priced models were augmented by a number of deluxe receivers having new and exclusively Crosley technical developments.

While the gathering was held primarily to discuss radio sales plans for the coming season, Shelvador refrigerators and the new Crosley Savamaid washers and ironers came in for considerable attention.

The new models were introduced by Powel Crosley, Jr., ably supported by Lewis Crosley, vice presidents J. P. Rogers and Powel Crosley III, Neil Bauer and advertising manager Glenn Corbett.

Mr. Crosley, Jr. gave a vivid picture of the reasons why 1936-37 will be one of the best years for radio sales yet witnessed.

On The Job



D. P. O'Brien of Cinaudagraph. This'll be a surprise to him. We snapped the shot while D. P. was "emoting" about P.M. speakers to a Milwaukee distributor.

EXPANSION

CHICAGO—Zenith Radio Corporation has leased a large building near one of its main plants to provide for increased production. Large volume sales of auto receivers is one reason for the establishment of "Plant No. 4."

PHILADELPHIA—Following its fifth expansion move in 14 years, International Resistance Co. now occupies spacious new top-floor quarters at 401 North Broad Street, this city. Space a block long is utilized for the manufacture and development of IRC resistors and volume controls.

WASHINGTON, D. C.—Walter M. Ballard Co. has opened a new Sparton radio studio at 1223 Connecticut Avenue. A pre-showing of new Sparton receivers was held in the lobby of the Shorcham Hotel.

NASHVILLE, TENN.—Gambill Distributing Co. (Crosley) is contemplating opening a branch in Chattanooga this fall.

SYRACUSE, N. Y.—The modernized store of the Clark Music Co. opened for public inspection April 15, with special entertainment throughout a three-day open-house period. Broadcasts direct from its own studio every evening. This firm was founded 78 years ago.

HARTFORD, CONN.—Hatry & Young, parts distributor, now has a third store, at 195 Cannon Street, Bridgeport. It's in charge of Emil Guggel. Its other branch outlet is in New Haven, Connecticut.

INDIANAPOLIS—The entire Home Appliance Division of Fairbanks, Morse & Co. has been moved to its new Indianapolis plant. Refrigerator production was carried on during the transfer without a break in manufacturing schedule.

NEW YORK—Sales and manufacturing under one roof has been effected by the Grebe Manufacturing Co., Inc.—formerly the Grebe Radio & Television Corporation. Its new quarters, with increased space, are at 119 Fourth Avenue, New York City.

Maurice Raphael, with Grebe since 1919, will continue to direct sales, assisted by J. D. Gibson, another radio veteran.

Cathode Kit

NEW YORK—National Union Radio Corp., by its Cathode Ray Tuning Indicator kit offer, is encouraging service-dealers to capitalize on the public interest in this type of tuning device. National Union provides the dealer or servicer with three cathode ray kits, complete with tubes and a series of two post card promotion pieces.

34 Per Cent Will Buy

24,866 women were asked last year concerning their interest in an electric refrigerator, 18.6 per cent said they intended to buy one. This year, 34,866 queried, the proportion jumped to 34.6 per cent. Survey conducted by Gerald Stedman, of the Cramer Krasselt Agency, Milwaukee.

Review of New Products

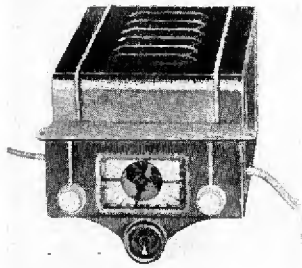

VISION RAY Auto Set

Cathode Ray tuning is incorporated in the new Model J-60 auto-radio of the Automatic Radio Mfg. Co., Inc., 122 Brookline Ave., Boston, Mass. This is a 6 tube set with direct tuning, simplified installation, dreadnaught construction and clear vision dial. —*Radio Retailing*, May, 1936.

TURNER Call Systems

Speech relay systems, which are growing so rapidly in popularity as they enable the executive to be in instant touch with his staff, saving time, steps and increasing efficiency, may be obtained from the Turner Co., Cedar Rapids, Ia.

There are three distinct types. The group call system permits any station to talk with any other station. Any number of outlying stations may be called at one time. The prices range from



\$125 for two-station system up to \$345 for the nine-station system. The selective speech relay system is composed of announcer station located on the desk and any number of outlying stations. The voice is carried only to the desired station and the response from that station is heard only at the calling station. The outlying stations cannot communicate between

themselves. \$140 for the two-station system with prices ranging up to \$370 for the nine-station system.

The super-selective system is a private system especially desirable in many offices. Any station in this system may talk to any other station. The conversation is private and eavesdropping is not possible. Prices range from \$170 to \$425.—*Radio Retailing*, May, 1936.

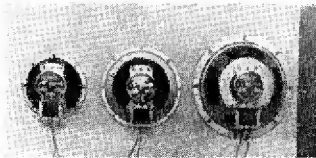

PM Dynamic Speaker

The new "Magna" permanent magnet dynamic speaker of the Unit Reproducers Mfg. Co., 999 E. Main St., Rochester, N. Y., comes in three sizes—5, 6 and 8 in. The life of this type of speaker is longer due to the permanency of the new magnet steel—no pot coil to burn out.

There is no heat to distort the voice coil, which is made of waterproof material. Tests made prove it will stand submerged in water for over 30 days without effect on the voice coil. Gives better performance and is less expensive to use in both a.c. and d.c. sets and auto sets, the statement reads. Saves from 1 to 2 amps. battery drain—15% to 30%. —*Radio Retailing*, May, 1936.

WEBSTER Amplifier

Wherever it is advantageous to provide four microphones—as in political halls where the speakers are likely to be separated, etc.—the Webster Co., 3825 W. Lake St., Chicago, Ill., offers its Model 4P-15 sound equipment unit. This unit mixes four crystal microphones without pre-amplifier. Any of the four inputs may be used for phonograph pick-up as well as crystal microphone.

As in all Webster-Chicago models of this size, it has tapped output to accommodate the various groups of speakers required. Undistorted output is 15 watts.—*Radio Retailing*, May, 1936.

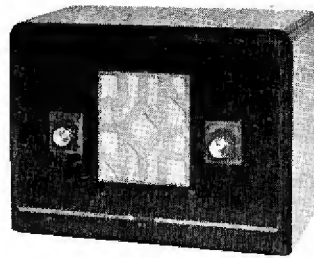

PRATT Glass Radio

To harmonize with interior decorative color schemes, Howard A. Pratt, 665 Fifth Avenue, New York City, offers a mirror glass radio in blue, green, rose, amber, crystal, gold and gun metal. The top panel may be monogrammed.

This is a superheterodyne set for both long and short waves and uses five tubes. Operates on a.c. or d.c.—*Radio Retailing*, May, 1936.

AMPLIVOX Noise Bucker

Adapted to superheterodynes using two or more stages of i.f., the "Noise Bucker" of the Amplivox Radio and Sound Laboratories, 227 Fulton St., New York City, may be classified as a signal limiting device which will properly adjust to operate satisfactorily on the receiver on which it is installed and will allow no noise interference

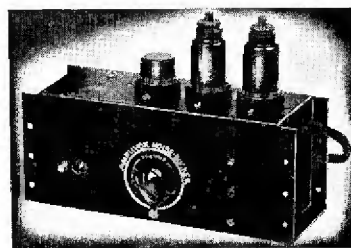

louder than the signal to pass through the receiver to the speaker. It is designed after the circuit by J. J. Lamb of the ARRL.

Electrical devices which normally blot out a considerable part of transmission, particularly when the listener is listening to shortwaves, can be reduced in intensity by the use of this device. While it will not eliminate natural static, it is said to soften this interference to a marked extent. Uses three metal tubes.—*Radio Retailing*, May, 1936.

ABC Short Wave Converters for Auto-radios

For owners of auto-radio sets who want short wave reception, the A.B.C. Radio Laboratories, 3334 N. New Jersey St., Indianapolis, Ind., make three types of converters. They are completely shielded and have motor noise filter built in. Mount on the bulkhead or any convenient place with single stud mounting.

Model 100 police converter with fixed condenser covers police short wave and amateur, aircraft and commercial bands from 1500 to 2600 kc. \$9.95.

Model 200 police converter with variable condenser covers the entire police and short wave bands from 1500 to 5500 kc. \$17.95.

Model 300 short wave con-

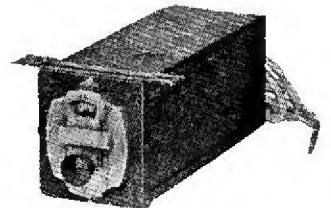

verter for world wide reception covers from 19 to 49 meters. Also makes possible the use of American made radios in foreign countries. \$19.95.

Model 400 police converter with fixed condenser covers the ultra shortwave bands from 5-10 meters.

This company also makes an all wave, under-car antenna to meet the signal strength requirements of all-wave radios. \$4.50.—*Radio Retailing*, May, 1936.

Cathode Ray Tube

The Alden Products Co., 715 Centre St., Brockton, Mass., offers, under its Na-Ald trade mark, a cathode ray tube. This is a 3-in. tube made especially for the service man and is said to have not only the performance of the larger tube, but does not depend on external circuit conditions to insure freedom from angular distortion or "keystoning."

No. EC3, 3 in. electron lens cathode ray tube, interchangeable with type 906, (green screen), is \$20. No. EC3B, interchangeable with type 908, (blue screen), is \$22.—*Radio Retailing*, May, 1936.

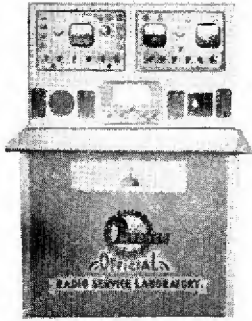

WEBBER Laboratory

A new complete service laboratory on wheels is announced by the Earl Webber Company of 1217 Washington Blvd., Chicago. The device, decorated in orange and designed to help sell service as well as do the work, contains a vibrator analyzer, vacuum tube analyzer, ohmmeter, ammeters and milliammeters, electrolytic condenser analyzer, paper condenser tester, universal field speaker and built-in antenna.

Meters are 4½ in. square, have special 4½ in. scale lengths. Voltages from 0 to 1,000, milliamperes from 0 to 1,000, amperes from 0 to 30, resistances from .05 ohms to 30 megohms, may be read. A built-in d.c. power supply delivers 35, 100 and 350 volts.—*Radio Retailing*, May, 1936.

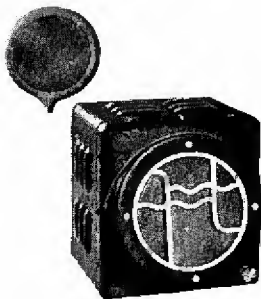

ADMIRAL Auto-Radio

The newly developed "series fed" antenna circuit with iron core antenna coil incorporated in the Admiral auto-radio made by the Continental Radio & Tel. Corp., 325 W. Huron St., Chicago, gives 2 to 7 times the antenna gain, it is claimed.

This is a 6 tube set (2 metal tubes) with vibrator "hash" filter and motor noise filter. Sturdy, easy-to-install single hole mounting for any one of four positions. The 6½ in. speaker is mounted on a predetermined "slant" and is not parallel to any of the surfaces of the housing or chassis. Control mountings available to match all instrument panels. Jack provided for overhead or rear twin speaker. List, \$39.50. Extra speaker, \$6.50.—*Radio Retailing*, May, 1936.

HICKOK Oscillograph

Model RFO-1 oscillograph just announced by the Hickok Electrical Instrument Co., 10514 Dupont Ave., Cleveland, Ohio, may be used for alignment of r.f. in intermediate frequency; r.f. distortion; a.f. distortion; modulation measurement, and the testing of coils, transformers, vibrators, etc.

The design of the r.f. section permits its use as a heterodyne type universal frequency modulator. With this

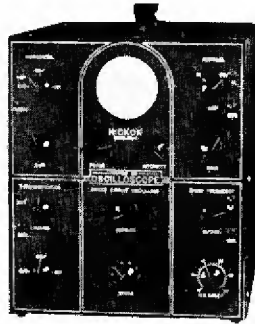

development, any r.f. oscillator may be used with this oscillograph to provide visual alignment at any frequency without the necessity of purchasing additional equipment such as wobblers, frequency modulators, etc.—*Radio Retailing*, May, 1936.

HOWARD Radios

A six-tube auto-radio with the Mallory synchronous vibrator has been brought out by the Howard Radio Co., 1731 Belmont Ave., Chicago.

This set has power output of better than 2½ watts without distortion and a non-metallic speaker grille to eliminate vibration and rattle. It may be installed in GM and Chrysler cars without drilling holes and in other cars by drilling two holes for secure mounting. Special instrument panel mountings are available. \$60.

Howard has also brought out a new small table set called the "Super Five." This is a two band set covering from the broadcast band up to 1750 kc, plus the 5.5 to 18 mc. bands. It is an a.c.-d.c. set with three color illuminated airplane dial.—*Radio Retailing*, May, 1936.

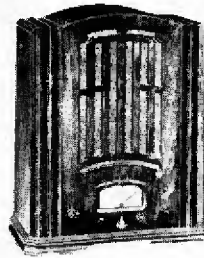
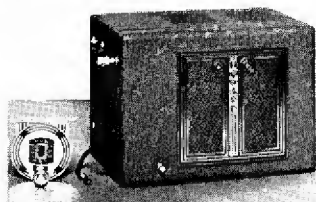

EMERSON Model 119

Metal tubes and an 8-in. dynamic speaker are employed in the new Model 119 three-band, six-tube ac-dc table set just announced by the Emerson Radio & Phonograph Corp., 111 Eighth Ave., New York City. This set also has the micro-selective tuning. \$39.95.

Model 108 announced recently is now available in black, ivory and walnut at the regular list price of \$24.95.—*Radio Retailing*, May, 1936.

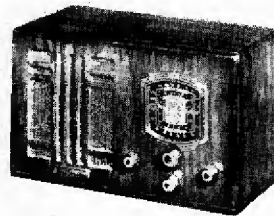

FREED Radio

A 6 tube, a.c., 3 band super-heterodyne with metal tubes is the latest addition to the line of Freed-Eisemann radios made by the Freed Mfg. Co., Inc., 44 W. 18th St., New York City.

It comes in a new design table model with speaker mounted to the left of the tuning controls. This cabinet may be had in walnut, maple or mahogany. Tubes used are 6A7, 6D6, 6H6, 6F5, 42 and 80. The wave length ranges are: 19-55, 200-550 and 75-200 meters.—*Radio Retailing*, May, 1936.

KINETIC Speaker

A line of Kinetic speakers using the new Alnico magnetic alloy is being made by the Arlab Mfg. Co., Inc., 1250 N. Paulina St., Chicago. These speakers are of the laminated armature construction and the magnets use about ¼ of an ounce of the Alnico alloy. The 5 in. speaker is \$3; 6 in. \$3.50, and 8½ in. size, \$5.—*Radio Retailing*, May, 1936.

SPARTON Auto-Radios

The new Sparton motor car sets are furnished custom-tailored to match the instrument panels of modern cars. They are easy to install and, with few exceptions, no suppressors are needed. Metal tubes are used. The dial is of the "no-glare" type.

Model 686 is a 6 tube super-het with 8 in. separate speaker. Filtered power leads

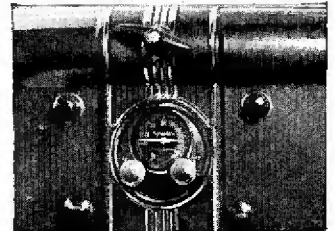

and antenna. Also available with header speaker. Priced from \$54.95 to \$59.95, complete.

Model 676 is also a 6 tuber. Has self-contained 6½ in. speaker, worm drive tuning. \$49.95.

Sparks - Withington Co., Jackson, Mich.—*Radio Retailing*, May, 1936.

Signal Generator

The latest model signal generator from the laboratories of the Superior Instruments Co., 139 Cedar St., New York City, besides affording all-wave coverage on fundamentals, and other usual advantages, contains several additional features. For example, the r.f. output may be taken from a high impedance or a low impedance post, with attenuation for either. The front panel has two extra

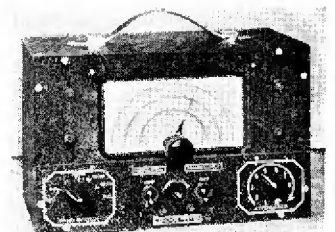

posts that enable leakage tests.

The r.f. coverage is from 110 kc. to 20 mc. in five bands, selected by a front panel switch. The dial is direct reading in frequencies and the five coil-switch positions are designated alphabetically, also in frequency ranges. Works on 90-130 volts, a.c. or d.c. Two type 37 tubes and a neon tube are used. One of the 37s is used as a Hartley r.f. oscillator and the other as the rectifier. \$12.40.—*Radio Retailing*, May, 1936.



TRIPLETT Tester

The popular twin instrument having separate a.c. and d.c. movements is contained in the Model 1200 volt-ohm-milliammeter of the Triplet Electrical Instrument Co., Bluffton, Ohio.

A tilting feature is also incorporated for adjusting the instrument to the proper alignment for correct readings. One switch quickly selects all instrument readings.

Scale readings are: D.C. 10-50-250-500-1000 volts at 2000 ohms per volt; 1-10-50-250 M.A.; 1500 ohms, 1.5 and 3 megohms; A.C. 10-50-250-500-1000 volts. \$32.50.—*Radio Retailing*, May, 1936.



SOLAR Analyzer

Designed to suit the needs of engineers as well as of servicemen, the Capacitor-Analyzer and Resistance-Bridge of the Solar Mfg. Corp., 599 Broadway, New York City, has a refined and extended Wien bridge built into instantly useful form for laboratory, shop and field work. All readings are secured direct from a color-coded panel, eliminating the need for cross reference to charts and graphs.

Comes in two models, each attractively housed in wood cabinet with detachable hinged covers.—*Radio Retailing*, May, 1936.

PIONEER Lighting Plant

A neat-appearing, compact a.c. lighting plant has been developed by the Pioneer Gen-E-Motor Corp., 466 W. Superior St., Chicago.

This plant is rated at 300 watts, 110 volts, 60 cycles and measures 20x11x11 in. A direct current winding is used

to supply 7½ volts, d.c., for charging 6 volt storage batteries. This feature will interest anyone who desires to use a.c. for lighting purposes and still have sufficient d.c. to charge 6 volt batteries.

A pulley is attached directly to the crank shaft of the engine and through use of a V-belt will operate washing machines, separators, etc.

Also advantageous for use in mobile radio units and sound equipment. Through its use, batteries are eliminated and standard a.c. radio equipment may be used.—*Radio Retailing*, May, 1936.

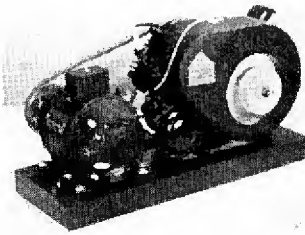

Dynamic Speaker Oil

An acoustical oil especially compounded for servicing speakers has been brought out by the Edelman Co., 6249 St. Lawrence Ave., Chicago, Ill. This oil is applied to new or old speakers by spray or brush. It is particularly useful for speakers edged with leather which becomes dry when several years old, affecting the tonal quality. Price per ounce bottle, with brush. 50c.—*Radio Retailing*, May, 1936.

LYNCH Auto Antenna

A new and improved under-car antenna has been developed by Arthur H. Lynch, Inc., 227 Fulton St., New York City. This antenna may be attached to any car in a short time. There are three distinct kits—the first is made up of the antenna alone and lists for \$3.75, the second is the transmission line and impedance matching transformers for the antenna and receiver, \$4; while the third kit is a combination antenna and impedance matching kit, \$7.50.—*Radio Retailing*, May, 1936.

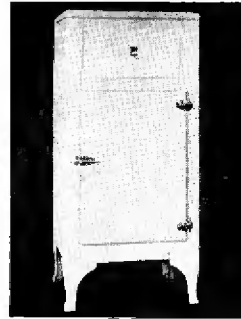
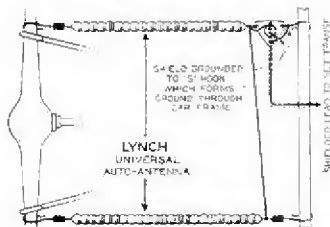

GIBSON "KeroUnit"

A kerosene-burning, absorption type refrigerator called the KeroUnit may be obtained from the Gibson Electric Refrigerator Corp., Greenville, Mich.

This model has a net cubic capacity of 6 ft. The re-energizing unit consists of a generator-absorber, the receiver, the condenser and their connecting tubes. The evaporator or freezing unit is built in with the receiver and mounted in the top of the food compartment. There are no valves or moving parts and the KeroUnit does not require gas or running water. It is semi-automatic in operation.—*Radio Retailing*, May, 1936.



HAAG Washer

Finished in oyster gray, the new large capacity washer of Haag Bros. Co., Peoria, Ill., lists at \$69.50. The vertically corrugated porcelain tub is 22½ in. in diameter—15 gallon water capacity. Available with or without drain pump.

Wringer is equipped with Haag mechanical hand safety feeder which feeds the rolls automatically with maximum ease and protection.—*Radio Retailing*, May, 1936.

WESTINGHOUSE Fan

A new fan, mounted on an adjustable standard and portable base, is announced by the Westinghouse Elec. and Mfg. Co., Mansfield, Ohio. This fan, due to its variable height mounting, is especially adapta-

ble to installations where portability is a factor. It eliminates the inconvenience of placing the fan on the chair or floor where it may become tipped over.

The base and lower part are finished in bronze kinkle with the upper or moving part in copper oxidized finish under clear lacquer. Available for a.c. or d.c. operation. \$28.—*Radio Retailing*, May, 1936.



KELVINATOR Coal Burner

The field of automatic coal burners has been entered by the Kelvinator Corp., Detroit, Mich., with a line of five models of the mechanical type to provide heating service for all types of existing heating plants. There are two small models for the small or medium sized homes and three larger models. Each may be used with warm air, steam, hot water or vapor heating systems.

Coal feed capacity per hour of the five new models ranges from 7 to 150 lb. The smaller size has hopper capacity of 350 lb. while all other models have the hopper capacities of 500 lb.—*Radio Retailing*, May, 1936.

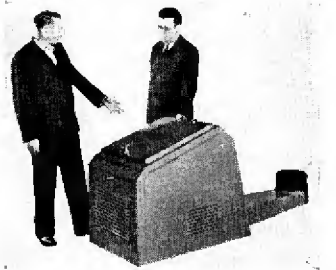

AG Crystal Mike

An improved diaphragm type crystal microphone is now ready at the plant of the American Microphone Co., 1915 S. Western Ave., Los Angeles, Cal. This microphone has unusually high output level, rugged construction and wide-angle pick-up. \$22.50.—*Radio Retailing*, May, 1936.

THE BEST INSULATED UNDER-CAR ANTENNA

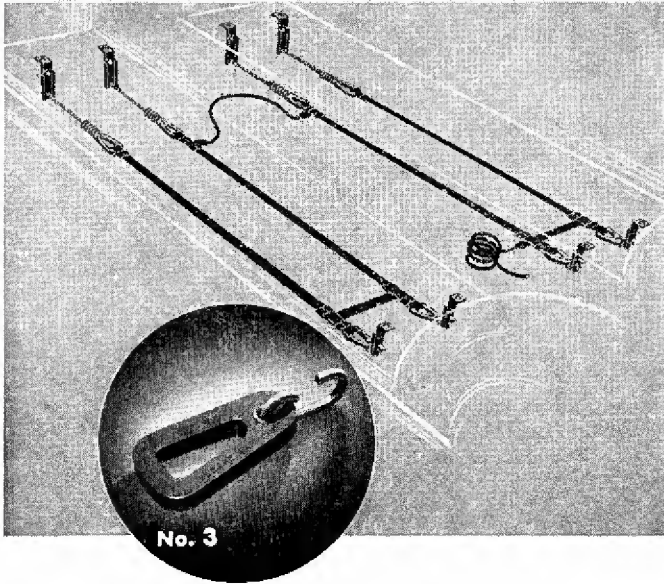

1 OF 12 EXCLUSIVE FEATURES
Insulator Links are Rubber Moulded Over
Bus Tire Cord. Perfect insulation—non-
stretchable—non-breakable.

★

INLANTENNA

PATENTS PENDING

It's on the New Cars

Here's why INLANTENNA is weather, abrasion and rust-proof—the most durable under-running board antenna ever developed. The continuous metal strip under each running board is completely jacketed with rubber especially compounded to resist moisture and ice formation. Lead-in and cross lead connections are soldered, tested and sealed by rubber boots. Insulator links are heavy rubber covered bus tire cord. Springs and brackets are rust-proofed. The perfectly shielded lead-in wire and cross lead are heavy duty, low loss insulated.

300,000 in Use

Grueling tests on automobile proving grounds and by leading radio manufacturers, as well as the experience of 300,000 motorists prove conclusively that INLANTENNA'S rubber coating is impervious to water, gravel, calcium, chloride, salt, tars and oils. This experience also proves that INLANTENNA'S

design and construction provide better reception, greater sensitivity and amazing signal pick up under all conditions. It eliminates directional effects—weather and road interference. INLANTENNA installed is two to four inches from any metal. It is least visible—vibration and rattle-proof.

*Easily Installed—No
After Service*

There are no holes to drill—adjustable brackets fit perfectly any under-car construction. A sturdy adjustable chain, furnishes accurate length and positive lock. INLANTENNA'S design and rugged construction eliminate after-service.

Adopt INLANTENNA. Leading automobile and radio manufacturers have approved and are using INLANTENNA as the only permanently weather and rust-proof antenna. It comes complete and individually boxed with instructions. Available through your present sources.

★

THE INLAND MANUFACTURING COMPANY
A GENERAL MOTORS SUBSIDIARY
DAYTON, OHIO



"Checkmaster"

A portable test instrument which includes fundamental facilities for receiver servicing as well as a practically "obsolescence proof" tube checker is being introduced by the Weston Electrical Instrument Corp., Newark, N. J.

In addition to the flexible tube checking system of improved electrical characteristics, the instrument provides voltage measurements in three ranges (0-10; 0-100; 0-1000 volts); resistance measurements (center scale—28,000 ohms; full scale—2 megohms), and a convenient condenser leakage test. Voltage and resistance measurements are instantly available through pin-jack connections and are read directly from a meter scale.—*Radio Retailing*, May, 1936.

ANSLEY Portable

A "quick-change" battery tray to facilitate replacing of batteries is incorporated in the new portable battery radio of the Ansley Radio Corp., 240 West 23rd St., New York.

This is a four-tube, super-heterodyne using dual purpose tubes. The speaker is of the 6-in. size. Batteries used are two standard No. 6 dry cells and two 45-volt B-batteries. Provision is made for connecting large batteries outside the case if the set is to be used permanently in one

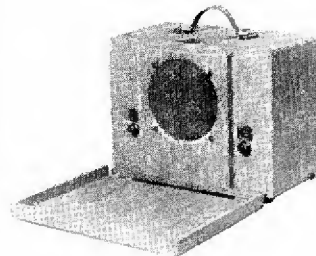

place. This set is ideal for camp, beach, canoe and any summer use and comes in a black leatherette or gray or tan airplane cloth case. Size 13x10½x8 in. Weight with batteries, 20 lb. \$39.50.—*Radio Retailing*, May, 1936.

SENTINEL Radio

A 5 tube a.c. model has been placed on the market by the Sentinel Radio Corp., 2222 Diversey Blvd., Chicago. It is a 2 band receiver, tuning the broadcast band, 535-1720 kc. and the 2300-2500 kc. band.

The chassis is of horizontal construction, mounted in an attractive low cabinet of interesting modern design, ideal for installation in a bookcase. A large airplane dial of distinctive design with each band illuminated in a different color adds to the appearance and facilitates tuning.—*Radio Retailing*, May, 1936.

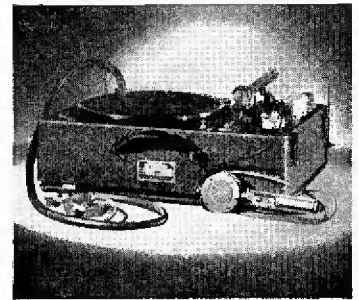

OPERADIO Sound System

Operating from a 6 volt storage battery, the new Model 112 mobile sound system of the Operadio Manufacturing Co., St. Charles, Ill., delivers 20 watts Class A power output. It comes complete with two speed turntable which will play up to 16 in. records; crystal contact type hand microphone and tubes. Made to mix both microphone and phonograph inputs. Equipped with false bottom for leveling of turntable. List price \$210.—*Radio Retailing*, May, 1936.

HAYNES Receiver

Complete coverage from 2½ to 555 meters with no skips is possible with the new Haynes R-S-R receiver made by the Radio Constructors Laboratories, 136 Liberty St., New York City. No plug-in coils are used and immediate shift from regeneration to super-regeneration is accomplished by turning the switch knob. Super-regeneration below 15 meters using simple efficient pin-jack plug-in coils. Receives the new "Apex" class broadcasting stations between 5 and 10 meters. Designed with the new octal metal tube sockets so that either metal or metal-glass tubes may be used. The price complete is \$24.65. Less cabinet and tubes, \$14.95.—*Radio Retailing*, May, 1936.



ATR A-Eliminator

For demonstrating and testing auto sets on regular a.c. lines (105-125 volts, 50-60 cycles) the American Television and Radio Corp., St. Paul, Minn., announces its A-Battery eliminator.

Equipped with an on-off switch, pilot light indicator, 10 amp. fuse, and encased in a heavy gauge metal cabinet with black wrinkle finish. 7½x7½x5 in. Weight, 20 lb. Dealers net price, \$12.95, complete. —Radio Retailing, May, 1936.

KATOLIGHT JR.

A 50 pound, 300 watt, fully portable power and lighting plant furnishing standard 110 volt, 60 cycle a.c. is announced by the addition of the "Kato-

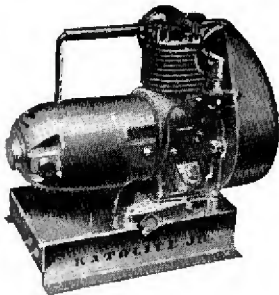

light, Jr." to the line of the Kato Engineering Co., Mankato, Minn.

The plant is a single unit, equipped with carrying handle. Generator is directly connected, and mounted on, engine block. Fuel tank contained in base. \$84.

Also made in plants of 150 watts, 6 volts, \$59.95; 200 watts, 12 volts, \$62; 300 watts, 32 volts, \$65; 300 watts, 110 volts, d.c., \$69.—Radio Retailing, May, 1936.

ICA Flexible Rack

Constructors of rack and panel jobs who have felt a need for a system which would allow any desired height rack and panel to be built using standard knock-down parts will be interested in the flexible sectional standard construction rack of the Insuline Corporation of Amer-

ica, 25 Park Place, New York City.

Any desired number of standard panels of any desired standard size may be accommodated simply by mounting together the requisite sections which are available in as many sizes as there are standard panel widths. This rack may be used with either the Bureau of Standards or Stromberg Carlson (W.E. Type) panels.—Radio Retailing, May, 1936.

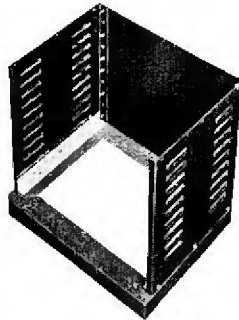

FOX Speaker

A wide range of frequencies may be reproduced with its low-level speaker states the Fox Sound Equipment Corp., 3120 Monroe St., Toledo, Ohio. All sound is strengthened but without annoying projectional features, it is claimed.

The mounting bracket is attached at the center of gravity making directional adjustment stable. The cradle is free to turn through a radius of 360°. The bell may be moved through 180° in a longitudinal direction. —Radio Retailing, May, 1936.



OHMITE Attenuators

For controlling the volume of high powered amplifiers and p.a. systems, the Ohmite Mfg. Co., 4835 W. Flourney St., Chicago, has brought out a new line of high wattage T-pads and L-pads. These units offer almost stepless control of the high power amplifiers. There are two lines, one rated at 25 watts and the other at 50—Radio Retailing, May, 1936.



New RCA VELOCITY MICROPHONE

Though designed especially for public address and sound reinforcing systems, the new RCA Velocity Microphone is also particularly well adapted to any other uses where a High Fidelity microphone is required. Note the attractive low price.

OUTSTANDING FEATURES:

- 1 High sensitivity.
- 2 50 to 10,000 cycles frequency range.
- 3 Designed for grid or transformer input.
- 4 Metallic shielding throughout.
- 5 Uniform frequency response.
- 6 Unaffected by moisture or barometric pressure.

 **COMMERCIAL SOUND SECTION**

RCA Manufacturing Co., Inc.

Camden, New Jersey • A Service of the Radio Corporation of America



SALES-BUILDING PROGRAM
for
JOBETS - DEALERS - SERVICEMEN

on
ARCTURUS 'CORONET'
The Perfected METAL TUBE

GET THIS

Step up your Sales and Profits

Don't wait! Join the other wide-awake radio dealers and repairmen who are selling the new 'Coronet' Metal Tubes for glass tube sets. Exclusive with ARCTURUS and the biggest SALES IDEA in the Tube Industry has ever seen. Mail coupon below for Folder explaining this Plan and how we cooperate with you.

ARCTURUS

'CORONET' METAL TUBES



Arcturus Radio Tube Co.
Newark, N. J. A-5

Send me full details of your Merchandising Plan on the new 'Coronet' Metal Tube for modernizing my customers' sets.

Name

Address

DEALERS SOUR ON SPIFFS

(Continued from page 11)

nite and continuous stimulation of retail salesmen. I am, however, firmly convinced that if it were not for the competition between manufacturers to see who can give away the most in money and merchandise regular contact by means of bulletins and letters, actually helpful to the salesmen, would prove more beneficial to all concerned than the present Spiff system."

Dealer Shying

Dealers are definitely sour on Spiffs paid by manufacturers to retail salesmen but hesitate to shout it from the rooftops for the same reason that individual manufacturers duck the issue . . . unwillingness to take the initiative alone. Curiously, there appears to be much more seething beneath the surface than the average retailer realizes, and this spotlight of publicity may be just the spark needed to start a cleansing conflagration. For 74 per cent of all dealers contacted by our editorial staff in the last 30 days feel about Spiffs as they do

about the itch. Another 6 per cent considers Spiffs ok where the objective of the manufacturer coincides with that of the dealer, or where the dealer carries only one line; both qualifications emasculating the plan in so far as the manufacturer is concerned.

Objections voiced by the trade, and we don't mean just the little guys, who might be accused of resurrecting the old sour-grapes gag, are as follows:

1. Manufacturer-paid Spiffs cause the salesman to lose sight of the store's interests.
2. Volume remains the same, for while premiums may swing sales to a particular line they do not bring in more business.
3. Spiffs encourage switching, which frequently leaves the customer with a bad taste in his mouth.
4. Subsidizing of salesmen makes it difficult for the dealer to do justice to more than one franchise.
5. Salesmen frequently pass the extra commission along, give the consumer the impression that radio is a racket.

Here are a few statements from

retailers that show pretty clearly which way the wind blows:

From the radio and appliance manager of one of the largest department stores in the country: "It is understood by all manufacturers and distributors who sell this company that our salesmen are never in on any deals. It does not matter whether the salesman qualifies or not. He is automatically out of such a proposition if he works for us. Should there be a violation of this rule out goes the merchandise, regardless of make. About two-thirds of the Spiff propositions in this city are originated by distributors or factory branches. Of course, the factory has to wink at such things or they would not happen."

From a nationally known music house: "We are unalterably opposed to the payment of Spiffs to our sales force by distributors or manufacturers for pushing the sale of their merchandise. We believe merchandise should be sold on its own merits and not through subsidy. All the manufacturers of standard-brand mer-

FLASH

ANOTHER NATURAL!!

ATR

Auto-Radio
"A" BATTERY
ELIMINATOR

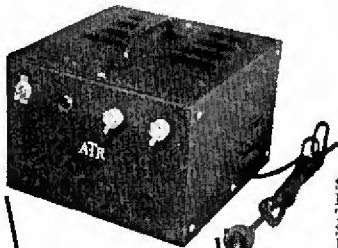

DEALERS
PRICE
\$12.95
Net
COMPLETE
10% higher west
of the Rockies.
Higher in Canada.
Packed one to a
carton.

SPECIALLY DESIGNED FOR
DEMONSTRATING AND
TESTING AUTO RADIO
SETS ON REGULAR A.C.
LINES, 105-125 VOLTS,
50-60 CYCLES.

Equipped with:
On-Off Switch
Pilot Light Indicator
10 Ampere Fuse
Rubber Mounting Feet
6-Ft. All-Rubber Cord Set

Cabinet is of heavy gauge
metal having attractive black
wrinkled finish.

Size: 7½" x 7½" x 5"
Shipping Wt. 20 Lbs.

OUTSTANDING FEATURES

- Eliminates Storage Batteries and Battery Chargers.
- Prevents the Possibility of Spoiling a Sale Because of a Run-Down Battery.
- Operates the Set at Maximum Efficiency at All Times.
- Delivers Pure Direct Current at the Correct Voltage for the Proper Operation of Any Auto Radio Set.
- Equipped with Full-Wave Dry-Disc Type Rectifier Assuring Noiseless Interference-Free Operation and Extreme Long Life and Reliability.
- Fully Automatic and Fool-Proof.

Write or Wire for Further Particulars
SOLD BY LEADING JOBBERS EVERYWHERE

AMERICAN TELEVISION & RADIO CO.

St. Paul, Minnesota, U. S. A. Cable Address: "LIKEX" N. Y.

HOME RECEPTION IN AUTOMOBILES

with "LONG-RANGE TWINS" Aerials

Sealed in Leak-Proof Rubber

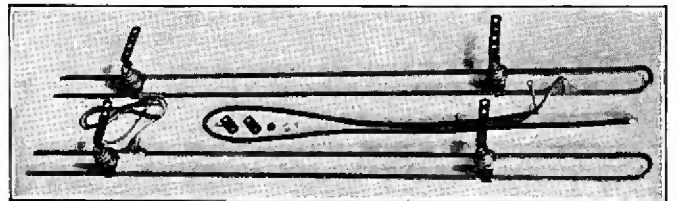

SIX NEW FEATURES ELIMINATE SIGNAL LEAK IN AUTO AERIALS

93% Signal Strength Efficiency according to Certified Laboratory Tests
JUST OFF THE PRESS—Free Copies Available—'AERIAL NEWS' All About
NEWEST DEVELOPMENTS In Automotive Antennae. Write for yours today.

WARD PRODUCTS CORP. 2129 Superior Ave.
CLEVELAND, O.

UNIVERSAL Velocity and Carbon Microphones



Universal's latest achievement—Ideal for stage use—Not affected by temperature or humidity—Flat frequency response curve from 40 to 10,000 c.p.s.; Output—63 db; Low impedance or direct to grid types. Compact, 2¾ x 4¾ in. by 1½ in. thick—Weight, less than 18 oz.—Head swings to any desired angle—Beautifully finished in black enamel and artistic chrome plate—Ask for new catalog sheet describing Models RL, RP, RH and CB—List \$22.50—Latest model music type sectional stand for above microphones—List \$10.00.

UNIVERSAL MICROPHONE CO. Ltd.
424 Warren Lane Inglewood, Calif., U. S. A.

chandise are giving Spiffs in some form or other, therefore nothing is actually gained in so far as the sale of any individual manufacturer's product is concerned. It is the retailer's obligation to pay his sales force—not the manufacturer's."

Appliance sales manager of a major utility: "No retailer in his right mind would permit any manufacturer or distributor to go over his head in this matter."

A radio chain: "I believe that tactics of this kind on the part of manufacturers or distributors are very destructive. We do not permit them in our stores. We feel that we should have absolute control of our sales force, rather than allow a distributor or manufacturer to control it by bribery. Our salesmen have instructions to be guided by the wishes of the customer, whenever possible. Spiffs do not fit into our method of operation."

The money spent by manufacturers and distributors to throw the hooks into competitive lines could be used to better advantage by the dealer, think many.

Says a typical Ohio small townner: "If a manufacturer has anything to give away he should give it to the

dealer to use for advertising. This will increase retail volume and help the individual manufacturer, too."

Says a Connecticut music dealer: "If there are any extra allowances that manufacturers or distributors can make these should be allotted to the dealer for volume business."

Says a Pennsylvania furniture house: "If distributors would allow us an extra discount or rebate and let us give salesmen Spiffs of our own where we feel it necessary the whole industry would be much better off."

Distributor Squeezed

If manufacturers and dealers have cause to cry in their beer about Spiffs then distributors are justified in erecting their own, personal wailing-wall. For the distributor is roasted between two fires . . . manufacturer pressuring for volume at any cost and retail salesmen insisting that bonuses paid by others be matched. And just to make things completely comfortable local bonfires have been liberally started by pyromaniacs in his own ranks.

Investigation discloses that 96 per cent of all jobbers have given Spiffs a whirl and that 85 per cent employ them at the present time. Competi-

tion forced the use of such plans, say 71 per cent, who inform us in no uncertain terms that they wish they were well out of the mess. Here are a few samples of distributor reaction:

From New York City: "We are against Spiffs in either direct or indirect payment, but competition has forced us to use them. At times we have had some success, but it has usually been short-lived because our competitors have trumped us. That is the greatest difficulty with Spiffs. You obtain an interest from your dealer or the dealer's salesmen for a short time, but you do not know when somebody is going to come along and trump you."

Another from the big-town: "Spiffs have been used by our firm for the past few months only and were forced on us by salesmen of certain stores. This applies to six of our accounts. We find that it helped sales only slightly. The amount of profit on certain types of radios does not warrant a large Spiff, and the continued use of same does not help the individual dealer, unless he, too, wants to push a particular line or model. It makes the salesman the real boss of the business."

New England: "As a rule, the bet-

CONFIDENT!...

● Sure he's confident . . . confident of a prosperous, well-paying tube business. He sells Sylvania's!

When he stocked his shop with Sylvania tubes he knew what he was getting . . . he knew the way Sylvania does business! Fair list prices . . . a high standard of quality backed by a six-months guarantee, and the services of a wide-awake engineering research staff!

He got what he expected and it's paying him dividends. He's making an extra profit on each tube and he's building customer goodwill with every sale he makes!

You can put your tube business where this man put his. Write today for full technical and sales information. Address the Hygrade Sylvania Corporation, Emporium, Pa.

SYLVANIA

THE SET-TESTED RADIO TUBE



ter type of dealer resents that type of promotion. Furthermore, where Spiffs are offered to a dealer handling several lines competition follows suit and when you begin to buy every sale the result is a total loss. Dealer salesmen, in order to earn an extra bonus will often make deals with the customer and this further stamps radio as an unethical business."

Pennsylvania: "We have never approved of this method of selling merchandise. Our experience has been, in the few instances in which we have tried it, that it does not help sales a great deal and after Spiffs are taken off it creates a bad feeling among the retail men. We would rather, if we had anything extra, give it to the dealer through discount or advertising and let him do his own merchandising."

Some jobbers feel that Spiffs can be profitable to all concerned if properly controlled. Good example of this thinking is the following statement from Wisconsin:

"It is my opinion that Spiffs, if used intelligently, can be made to bring out the best in retail men as an added incentive in putting over a specific contest or promotion. If used generally, however, without time lim-

itation, it simply resolves itself into a contest between manufacturers and distributors to see who can offer the best in the way of commercial bribery. Unfortunately, many manufacturers and distributors seem unable to distinguish between a sales contest which affords the retail men opportunity to earn additional cash and open-market bidding for the retail salesman's effort."

An Indiana operator seconds the motion: "We have used Spiffs but only with the consent of the employer, and only to promote the sale of the higher-priced merchandise. When used in that manner we have found that it helped to raise the average unit price on sales. We have, however, watched other wholesalers use bonus plans to promote sales of their lines in preference to others. In every case this developed into a contest between wholesalers to see who could pay most. Results were invariably disastrous."

References to the legitimacy and value of extra commissions used to induce retail salesmen to sell-up, as contrasted with Spiffs designed purely as a lever to improve competitive position, have cropped up in so many interviews that we consider it

desirable to emphasize this distinction.

An explosive situation, this, with most manufacturers swinging lions, willing . . . yea, eager . . . to let go; dealers fidgeting in the stands and distributors heading for the trees.

Somebody, soon, is going to slip. And after the deep red blotches in the arena are covered with sand everybody will feel better.

Ear-Minded

We're ear-minded say the scientists. All tests prove that impressions received auditorally are more lasting, appeal more to the imagination and are less tiring than those received visually. This, according to a compilation of 21 eminent professors and their exhaustive tests, just released by the Columbia Broadcasting System.

Example: In all tests where college students were asked to memorize a series of facts, the audio method of presentation scored from 7 to 23 per cent greater accuracy than the visual.

From which it may be deduced that audio reception is some pumpkins—well able to hold its own on the basis of sound (no pun intended) scientific fact against all comers.



You Can Sell

Outdoor Radio

this Summer

This compact portable battery radio with 4-tube superheterodyne circuit weighs only 20 pounds, complete with six inch speaker. Batteries plug in, no wires to connect. Attractive cabinet, choice of finishes.

Write for special Authorized Dealer Franchise covering portable radio and famous Ansley Dynaphone phonograph combinations.

ANSLEY RADIO CORPORATION
240 West 23rd Street, New York, N. Y.

ANSLEY Portable BATTERY RADIO

NEW CONVENIENCE • FLEXIBILITY • ECONOMY
in Speaker Replacements—with the New
"CHANGEABLE FIELD"
OXFORD SPEAKERS



● Now—amazing new servicing convenience and economy—with these improved Oxford Electro-Dynamic Replacement Speakers! A simple change of field coil gives you the proper combination of field and transformer for the "job" when you need it. Universal transformer matches any tube. Voice coil remains centered! Available in 6", 8" and 11" Models.

Ask Your Jobber—or Write Now For Bulletin 361R

OXFORD-TARTAN
RADIO CORPORATION

915 W. VAN BUREN ST. • CHICAGO, U. S. A.

Export Division:
15 Laight St.,
New York
Cable: "ARLAB"

UTAH RADIO PRODUCTS CO.

Utah FLASH

URPC 820 RR5 CHICAGO ILL
UTAH VIBRATORS STAND UP DASH
USE THEM EXCLUSIVELY AND BACK
UP YOUR SERVICE WORK
UTAH RADIO PRODUCTS CO

TEAR OUT THIS AD—PIN TO YOUR LETTERHEAD AND MAIL TO
DEPT. R. R. FOR FREE CATALOG

MEET YOUR EQUAL

(Continued from page 17)

are well-groomed, affable, willing. Enters a prospective customer and they greet her courteously, tune in the demonstration set, recite some of the patter from the sales manual of the manufacturer. They are perfect clerks. But—

They are not business men.

Just as an example: A check was recently made on a considerable number of radio stores. Professional shoppers were sent out; they went to radio departments and evidenced keen interest in the new sets; they hesitated; could not make up their minds; finally departed. Only in a very few cases did the floorman attempt to secure the names and addresses of these obviously hot prospects. They were permitted to walk out.

Now, we all know that it is very seldom that a piece of high-priced merchandise is sold off the bat on one interview. Follow-up by phone, mail or in person is necessary nineteen times in twenty. But to follow, you must know whom you are following and where he lives.

Another point is that so few radio

salesmen take the trouble to study radio from the listener's standpoint. Suppose the prospect is an Italian—and it's pretty easy to spot an Italian. If you tell him that from this set you are recommending he can hear the news from Rome, Mussolini's speeches and the Italian opera, you touch a chord which is much more responsive than any amount of technical talk.

Not that I decry the basic knowledge of the technicalities. As has before been pointed out, the milk routeman has got to know the merits and limitations of everything from pump water to nanny-goat's milk, and similarly the radio salesman must know the how-come of pretty much everything from the studio mike to the listener's tympan.

He should know it, first, as the foundation of self-confidence, and second, as a bolster to his own self-respect. But never as a basis of show-off.

There comes to memory a personal incident in my own radio experience.

I am a very dumb ox on this business of radio. I do not know how it happens or why. To me it is a holy miracle, and when I listen to that Stradivari violin of Rubinfoff, played

a thousand miles away, I get a thrill which loosens my toe-nails. Well, to get on with the story: This venerable radio of mine was not coming through so hot, and I sought the advice of an expert. He bewildered me for an hour with some thousands of words, none of which I understood, and so I went home dazed and discouraged. It so happened that that very evening my friend Captain Shangraw of American Airways blew in to Cleveland airport, called us up and invited himself to dinner. Shang is chief of chit-chat for the air line, established the system whereby flying pilots talk to ports, and in his Army days was given some of the toughest assignments in ground-to-air communication. I told him my trouble; he dialed in for a couple of minutes and gave me the answer in three words. "Halve your antenna."

This business of radio retailing is just as simple as the business of running a milk route. You gotta contact the customer. You gotta sell the customer. You gotta advise the customer as an expert and say what you know in understandable words. You gotta get the money. And finally you gotta do a certain amount of garbage collecting when something goes blooey.

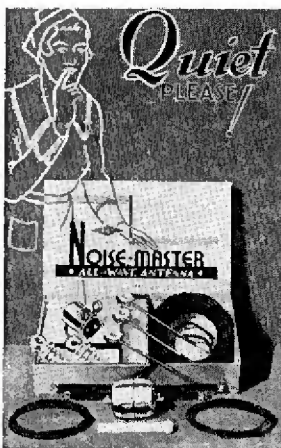

"Noise-Master" makes every receiving set a BETTER set. Electrically AUTOMATIC in operation. Eliminates "man-made" static on both broadcast and short-wave lengths.

List price . . . **\$6.75**

Also available with special transformers for European broadcast bands . . . list. \$7.00

CORNISH WIRE CO., Inc.
30 Church St., New York City

We can make
it worth your
while to take
an **USL**

Radio "A" Batteries

We've been building batteries for thirty-seven years—and if there's a finer product on the market than USL—or a better money-making proposition for the dealer—we never heard of it. Write and see what USL has to offer.

USL BATTERY CORPORATION
Niagara Falls, N. Y. Oakland, Cal.
Oklahoma City, Okla.



**Ken-Rad
Radio Tubes**

The Ken-Rad name means finest engineering, highest quality, perfect performance. Write for our complete dealer sales plan to learn how to increase radio tube business.

Glass or Metal
Radio Tubes

The Ken-Rad Corporation, Inc., Owensboro, Ky.

Division of The Ken-Rad Tube and Lamp Corporation
Also Mfrs. of Ken-Rad Incandescent Electric Lamps

Compact... Complete... Inexpensive

THE WESTON CHECKMASTER

MODEL 771

\$ **45⁰⁰** NET
TO DEALERS IN U. S. A.



1. Tests all tubes—has spare sockets
2. Neon Short Check while tubes are hot
3. Cathode Leakage Test
4. Individual tests on elements of diodes
5. Voltage ranges for point-to-point testing
6. Resistance ranges for continuity testing
7. Neon high resistance leakage test
8. All readings on one legible, open-scale meter—the famous WESTON 301 in modern rectangular form
9. Positive line voltage control
10. Striking design and finish— for home or store use

Convenience, simplicity of operation, and dependable accuracy are combined in this new CHECKMASTER. It's extremely portable . . . yet its striking design and finish makes it ideal for shop and counter use. But *out in the field* is where it will save time and make real money for servicemen. And it's an instrument that will last for years . . . being WESTON built, and designed to take care of possible future tube changes. Get full information on Model 771. Return the coupon below. . . .

WESTON ELECTRICAL INSTRUMENT CORPORATION, 581 Frelinghuysen Avenue, Newark, New Jersey

Name _____

Address _____

City _____ State _____

**"I WILL SELL YOU THIS
SUPREME ANALYZER**

**FOR ONLY \$4^{.50} DOWN AND
\$3^{.94} PER MONTH!**



*Your Parts
Jobber*

Every parts jobber in the country can now let you have any instrument in the famous SUPREME line — tube testers, analyzers, signal generators — on SUPREME'S own sensationally low S. I. C. Easy Payment Plan! There is no red tape. Ask your jobber or write the factory!



**SUPREME 385
AUTOMATIC \$8.50 DOWN
\$7.72 MONTHLY**



**SUPREME 89
DELUXE 7-IN-ONE
TUBE TESTER \$5.00 DOWN
\$4.55 MONTHLY**

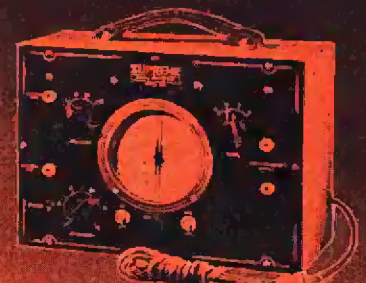

**SUPREME 189
SIGNAL
GENERATOR \$4.00 DOWN
\$3.66 MONTHLY**

SUPREME INSTRUMENTS CORP. GREENWOOD MISS., U. S. A.
EXPORT DEPT., ASSOCIATED EXPORTERS CO., 145 W. 45th STREET, NEW YORK, N. Y., CABLE ADDRESS: LOPREH. N. Y.

Beam Power 6L6

Of major importance to designers of radio and sound equipment is the about-to-be-announced 6L6, a metal tetrode capable of delivering 34 watts of audio when used in push-pull without grid driving power or 60 watts with 400 milliwatts input. Up to 11.5 watts may be obtained from single ended Class A circuits using fixed bias.

Radically new in principle, the electrode structure from which the term "beam power amplifier" is derived is shown in the accompanying sketch. It consists of a flattened cross-section cathode surrounded by an elliptical control grid. A screen, also elliptical, surrounds the control grid, has the same number of turns and is lined up so that individual turns are directly behind those of the control grid. Two metallic,

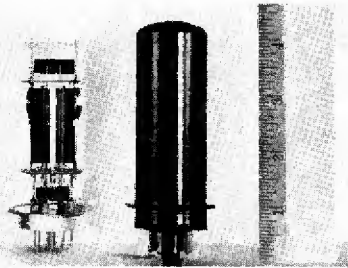

beam-forming plates are placed at the ends of the elliptical grid structure, close to the grid-supporting side rods. These plates are internally connected to the cathode. Around the structure so far described is the plate, the two curved areas illustrated effectively collecting electrons.

In operation, electrons emitted by the cathode are constrained to flow in two streams by the beam-forming plates. They are "sliced" on the way toward the plate by the control grid turns. Because screen turns are directly behind control grid turns few electrons strike the screen, hence screen current is low. Concentration of the electron stream by effective beaming produces relatively high electron density in the region be-

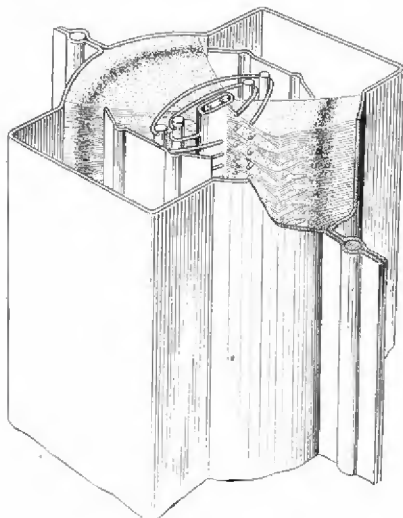

TYPICAL OPERATION CHARACTERISTICS OF BEAM POWER TUBE

		SINGLE TUBE OPERATION			PUSH-PULL OPERATION			
		1	2	3	4	5	6	
Plate voltage....	E_b Volts D.C.	250	375	375	250	400	400	} per tube plate to plate
Screen voltage....	E_{c2} Volts D.C.	250	250	125	250	300	300	
Control-grid bias	E_{c1} Volts D.C.	-14.0	-17.5	-9.0	-16	-25.0	-25.0	
Zero signal plate current.....	I_{b1} MA. D.C.	72.0	57.0	74.0	60	50.0	50.0	
Full signal plate current.....	I_{b1} MA. D.C.	79.0	67.0	26.0	70	76.0	114.0	
Zero signal screen current.....	I_{c2} MA. D.C.	5.0	2.5	0.7	5	2.5	2.5	
Full signal screen current.....	I_{c2} MA. D.C.	7.5	6.0	1.8	8	8.5	9.5	
Signal.....	Peak volts	14.0	17.5	8.0	16	25.0	42.5	
Load.....	Ohms	2,500	4,000	14,000	3,000	6,600	3,800	
Power output....	Watts	6.5	11.5	4.3	14.5	34.0	60.0	
Total distortion*	Per cent	10.4	14.5	9.0	7.0	2.0	2.0	
2nd harmonic....	Per cent	9.7	11.5	8.0	
3rd harmonic....	Per cent	2.5	4.3	4.1	2.0	2.0	2.0	
Peak grid power..	MW.	0	400	

*For the conditions of Column 1—fourth harmonic 0.35%, fifth harmonic 0.1%, higher orders less than 0.03%.

tween plate and screen. This region of "potential minimum" repels secondary electrons from the plate which might tend to travel back directly into the beam. Secondaries are prevented from returning to the screen at the edges of the beam by the action of the beam-forming plates. Thus, electrons themselves act to suppress secondary emission and high efficiency is secured without the use of an actual, physical suppressor.

Of additional interest is the reduction of third and higher order harmonics. Second harmonic distortion is increased in order to achieve this end but such distortion is readily reduced by the use of push-pull circuits. And in single-tube, resistance-coupled circuits it can be made relatively small by generating out-of-phase second harmonics in the pre-amplifier.

Equipped with a standard octal base, the 6L6 has a 6.3 volt, 0.9 ampere heater. Socket connections, looking at the bottom of the socket and reading clockwise after the locator pin, are: shell, heater, plate, screen, grid, blank, heater, cathode.

2-Volt Tube Switching

By means of a suitable switching scheme, a receiver that employs the two-volt series of tubes can be designed to operate from several types of A and B voltage sources. For example, the switching scheme can easily permit series filament operation from a six-volt storage battery or parallel filament operation from a two-volt air cell. If B voltage is furnished by a mechanical B-supply unit the switching scheme can also connect the grid return leads to the proper points in the filament circuit in order to obtain bias.

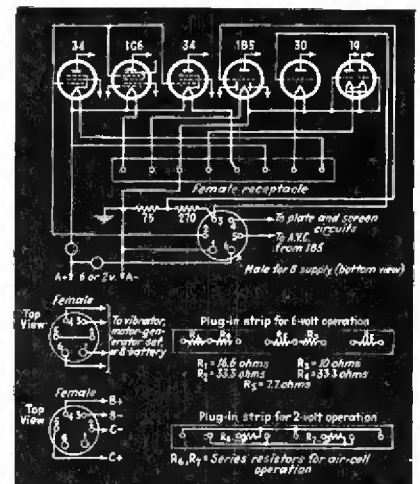

5W4

The 5W4 tube is a new full wave, high vacuum rectifier having the following characteristics:

Filament voltage (a.c.)	5
Filament current	1.5
A.C. plate voltage per plate RMS....	350
D.C. output current	110

The tube is 3½ in. long, has a maximum diameter of 1½ and uses a small octal base. Socket connections, seen from below and read clockwise following the locator pin are: Shell, filament, blank, plate number one, blank, plate number two, filament.

Thus, a single switching arrangement can provide for the operation of a receiver from either a six-volt storage battery and mechanical B-supply unit or a two-volt air cell and dry B and C batteries. The diagram shows a plug-in switching arrangement that has been installed in several receivers in order to facilitate such operation. The exclusive use of filament type tubes will insure low power consumption, regardless of the source of filament power.

EACH TRIPLETT MASTER UNIT

Now
IN
ALL-METAL
CASE

STRONGER
PERFECT SHIELDING
NO INCREASE IN COST
MORE PROTECTION
FOR INSTRUMENTS

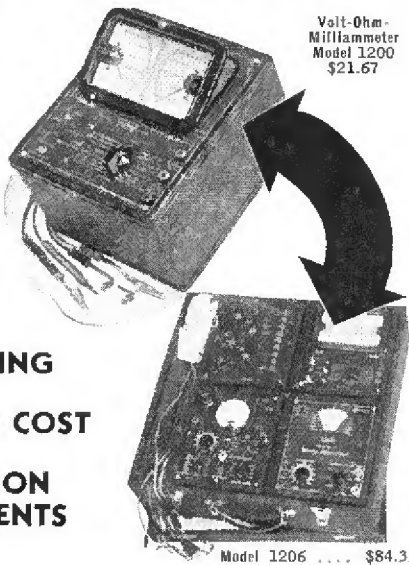

Volt-Ohm-Milliammeter
Model 1200
\$21.67

Model 1206 \$84.33

**No Serviceman should be without
Model 1200 Volt-Ohm-Milliammeter.**

Reads D.C. 10-50-250-1000 volts at 2,000 Ohms per volt; 1-10-50-250-Milliamperes; 1500 Ohms; 1.5 and 3 Megohms; A.C. 10-50-250-500-1000 Volts.

Has these Triplett features:

- SEPARATE A.C. AND D.C. METERS
- TILTING FOR ACCURATE READING
- OHMS SCALES SEPARATELY ADJUSTED
- LOW LOSS SWITCH
- ALL METAL CASE

(Model 1206) Showing all four Master Units in Carrying Case. Can be purchased separately:

	Dealer Net
MODEL 1210—A TUBE TESTER,	\$20.00
MODEL 1220—A FREE POINT TESTER	10.00
MODEL 1231 ALL WAVE SIGNAL GENERATOR D.C.	26.67
MODEL 1232 ALL WAVE SIGNAL GENERATOR A.C.	26.67
MODEL 1204 LEATHERETTE CARRYING CASE WITH DEMOUNTABLE COVER	6.00
MODEL 1207 (same as Model 1206 except has A.C. Signal Generator No. 1232)	84.33

See them at your jobbers. Write for details.



MAIL THIS COUPON TODAY!

Triplett Electrical Instrument Co.
205 Harmon Drive, Bluffton, Ohio
Without obligation please send me
..... More details on Model 1200.
..... More details on Model 1206. New 1936 Catalogue.
Name,
Address,
City, State

2 P. A. SYSTEMS FOR THE COST of 1 Universal 6 V (D.C.) or 110 V (A.C.) (PATENT PENDING)

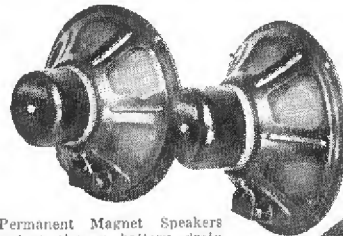

Permanent Magnet Speakers
reduce storage battery drain
by 3 amperes.

- 20 Watts Output
- Amplifier and Turntable built in one unit
- Two 12" Permanent Magnet Speakers
- Hand Type Dual Diaphragm Crystal Microphone

Strict Dealer Policy
Fully Licensed
Time Payment Plan



System MP-420

The economical system for the radio service dealer. This system can be used on either 6 V (D.C.) or 110 V (A.C.) by simply plugging in the right power pack. Thus you have two complete systems. It can be used for any kind of rental and has many distinct applications for sales where this type is most ideal.

The Webster Company
Section MY-8,
3825 W. Lake St.
Chicago, Illinois
Without obligation please send me
 More information on System MP-420.

See This System At Your Jobbers.
Send for Complete Catalog.

Name,
Address,
City, State

Don't Guess About Horns —

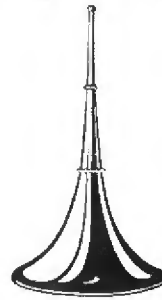

Fox Horns, manufactured only in Fox Sound Laboratories, are in a class by themselves. They are designed to put the proper acoustical load upon the diaphragm and are of proper weight according to size.

Write today for catalog, price list and technical data sheets on complete line of Fox Sound Equipment.

FOX SOUND EQUIPMENT CORP.
3120 Monroe St. Toledo, Ohio



The EYES have It!

YOUR eyes and the MAGIC TUBE see all, know all . . .
QUICK AS A WINK!



**CAPACITOR-ANALYZER
and RESISTANCE-BRIDGE**

Type CB-1-50, 110 volts, 60 cycles, list price \$32.00.
Dealer's net \$19.20
Type CB-Z-U, 110-220 volts, 25-60 cycles, list price, \$40.00. Dealer's net. \$24.00

Capacity, power factor, leakage, resistance, directly on the panel. The highly sensitive No. 205 Cathode Ray Tube is used for balancing. Dials are color-coded to match settings. A refined and extended Wien bridge, built into instantly useful form for laboratory, shop and field work.

WRITE FOR COMPLETE DETAILS
SOLAR MFG. CORP., 599-601 Broadway, New York City

MEN AT WORK



Six budding trouble-shooters from N.R.I. absorb some practical experience in the Brooklyn, New York shop of James L. Kearns, the gentleman at the left

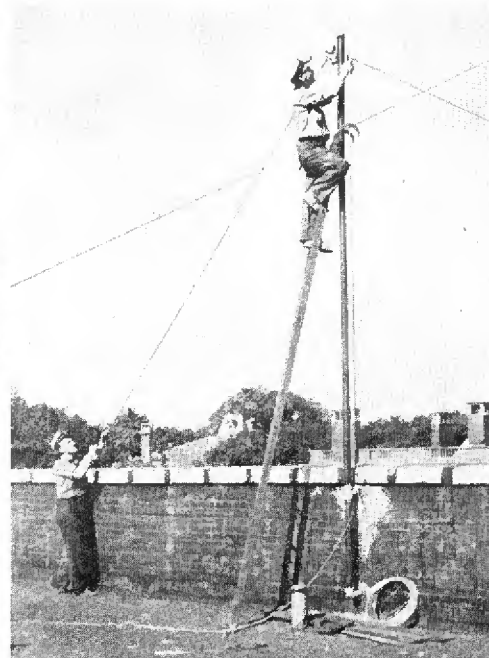

Frank Bestine, Buffalo, does the shinnying while Clarence Schuh parks on terra-firma

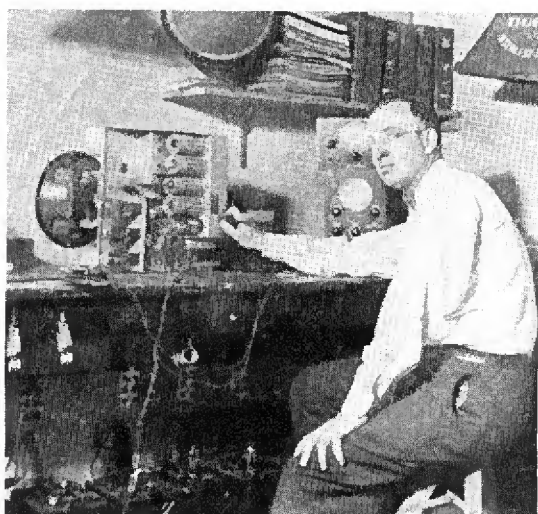

Watertown, Wisconsin, folks think so much of Erwin Knight they made him chief electrical inspector

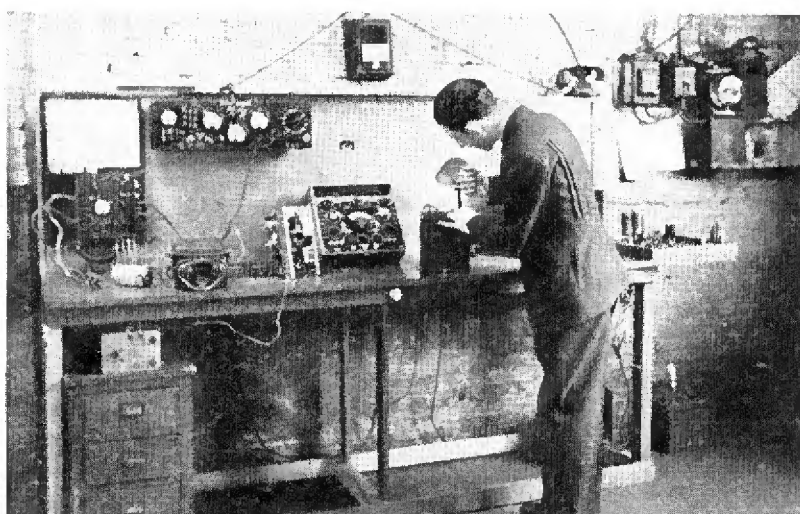

Paul G. Freed, of Philadelphia, claims the new 4-meter auto-radio test gadget hanging up on his bench will do everything but put out the cat

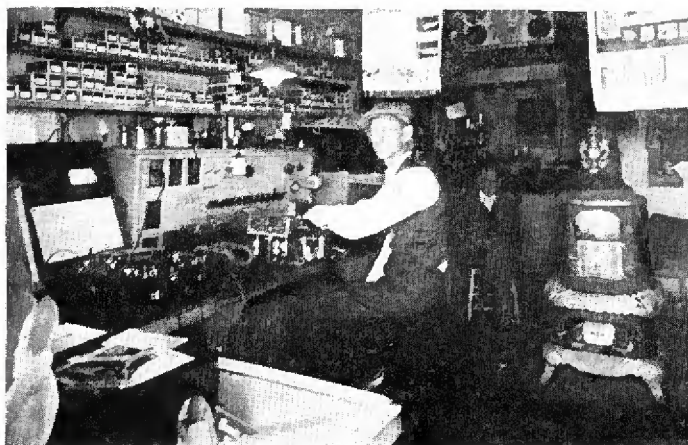

Here's a shop city-slickers might be proud of. Subscriber Ewald, of Fairfield, Illinois, serviced 403 different makes last year

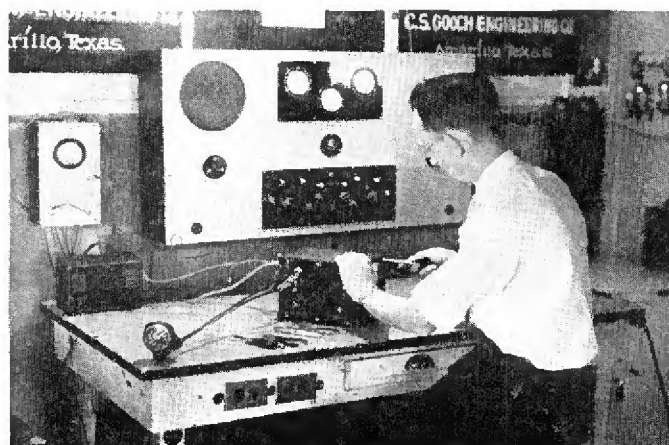

Plenty of light on the subject aids a good repairman in the shop of C. S. Gooch, Amarillo, Texas, car-set specialist

How To Build Economical Decade Resistor And Condenser Boxes

By G. F. Benkelman

Continental Carbon, Inc.

BECAUSE of the high cost of decade condenser and resistor standards, radio servicemen have for the most part struggled along without these valuable laboratory devices. Despite the fact that many bridge circuits have been published suggesting the advantage of comparing standard resistors or condensers with unknown units, to determine the ratios and hence the values of the unknown units, few suggestions have been made relative to construction of economical standards.

The two instruments which follow may be built by any serviceman and require the least number of parts with which we believe it is possible to assemble satisfactory decade condenser and resistor boxes.

In the resistance decade circuit (Fig. 1) only four semi-precision resistors are employed per decade. In conjunction with a ten-point, constant-contact, double-deck rotary selector switch a decade of values may be selected. By combining two, three, or four of these switches with the values of resistors recommended in the table below, a complete decade resistance box may be assembled. The use of one-watt semi-precision insulated carbon resistors

simplifies and reduces the normal cost of standards. Semi-precision resistors are accurate enough for the average run of radio testing service.

Resistor Assembly

The under panel view of the resistance decade box (Fig. 3) shows the compact assembly possible with insulated resistors. Each decade is assembled before mounting, hence the only operation to be performed after mounting is the joining of the respective sections and the completing of the connections at the binding post.

The following values of resistors are recommended for four decades:

Decade No.	R1 Ohms	R2 Ohms	R4 Ohms	R5 Ohms	Range of Decade
1	100	200	400	500	100-900
2	1000	2000	4000	5000	1000-9000
3	10M	20M	40M	50M	10M-90M
4	100M	200M	400M	500M	100M-900M

Condenser Assembly

The condenser decade box employs the same general principle of connections, and in addition incorporates a 1000-ohm resistor and switch for discharging the condensers after use on high voltage circuits. The diagram

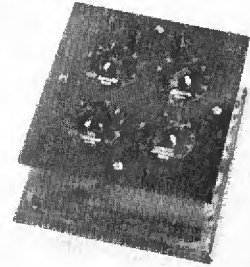
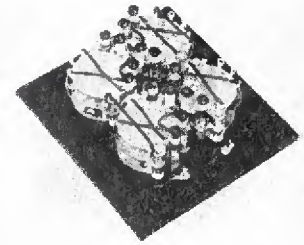

FIG. 3—Open and closed views of the completed resistor box

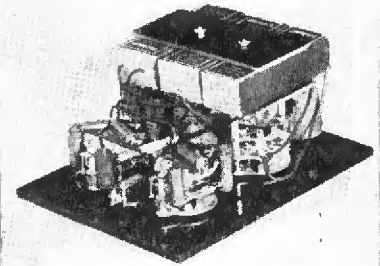
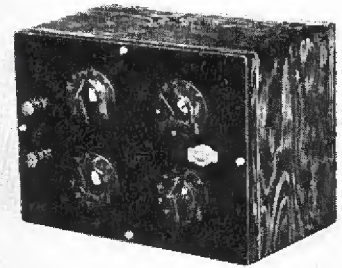

FIG. 4—Internal and external views of the companion condenser unit

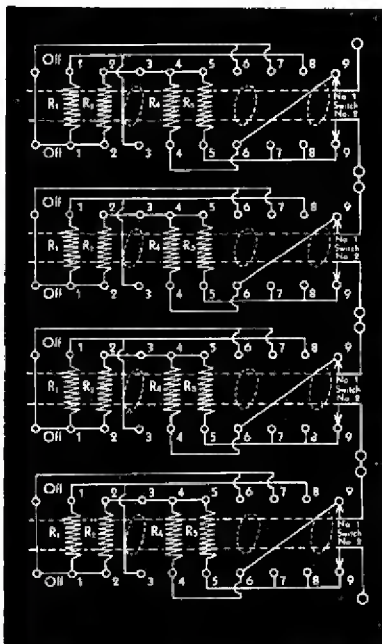

FIG. 1—Decade resistance box circuit

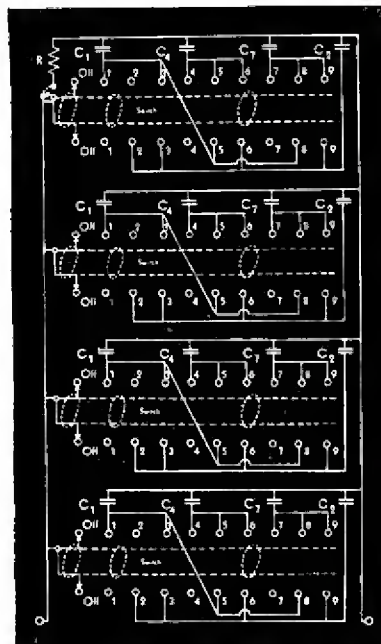

FIG. 2—Decade condenser box circuit

(Fig. 2) illustrates a four decade assembly. Three of the decades using small, cylindrical 600 v. semi-precision condensers may be assembled on the switches before mounting. The fourth decade condensers are too large to mount directly on the switch terminals, hence extension bolts and spacers are used on two of the decade switches to permit mounting these larger units between bakelite panels. The interior illustration shows this panel and its associate condensers. The mounting bolt extensions are visible on the two decade switches near the binding posts.

A standard toggle switch of the single-pole double-throw type serves to connect the 1,000-ohm capacity discharge resistor. In addition to the ten-point, constant contact, rotary switches the following semi-precision 600 v. condensers (5 per cent tolerance) are all

that are required to give a range of 0.001 μ f to 9.999 μ f:

Decade No.	C1 μ f	C2 μ f	C4 μ f	C7 μ f	Range of Decade μ f
1	.001	.002	.004	.007	.001 - .009
2	.01	.02	.04	.07	.01 - .09
3	.1	.2	.4	.7	.1 - .9
4	1.0	2.0	4.0	7.0	1.0 - 9.0

It is not advisable to assemble lower decades of values due to the probable errors induced by the capacity of connecting wires and the necessity of shielding such low capacities. Higher ranges would become too bulky to be of much practical value. The use of paper condensers throughout eliminates all concern about the polarity of the connections.

The neat appearance of the finished condenser and resistor box depends entirely upon the ingenuity of the builder. The two designs illustrated are assembled from $\frac{5}{8}$ in. birch veneer, and may be finished in walnut or mahogany stain protected by two coats of shellac. The dial plates are etched types with nine points and an off position. Insulated binding posts are recommended to prevent the possibility of accidental shock.

"A" Eliminators As Emergency Vibrator Supplies

By George P. Dey

Old "A" eliminators prove satisfactory for emergency tests on vibrator units where no storage battery is readily available. Even 5- and 6-tube battery receiver may be operated on the bench with fair results if a 2,000 mike, low voltage electrolytic condenser is placed across the output of the eliminator.

Condenser Gang Rotor Trouble

By R. L. Wittman

Of late I have been called upon to correct trouble in variable condensers used in many small, cheap receivers having no take-up adjustment on the rotor shafts.

If condenser frame section is slotted or can be drilled a long bolt is carried from one end to the other. Tightening on the frame pulls the bearing of the rotor tighter and corrects trouble. On some units it is necessary to put a clamp around the whole assembly. On some makes the bolt goes through the top, on some the bottom and on others the center of the outside edge.

Any arrangement which will permit the frame to be squeezed up on the rotor bearing will work. Re-aligning is generally necessary after such jobs.

SHORTCUTS

Bench Light Reflector

By Paul E. Grivet

Proper bench lighting aids accuracy and speed. After trying several methods of achieving it, all more or less satisfactory, I worked out the following reflector scheme and it fills the bill.

For my 8 ft. long bench a framework 5 by 3 ft., made of 2 x 2 wood members, was constructed. The ends of the individual pieces were cut as shown and a single $\frac{1}{4}$ in. bolt used at each corner. Tinned sheet iron was secured and a "roof" built over this framework, with a rise of 12 in. in the center. A 2 x 4 was bolted across the center of the framework, running the long way, and three light sockets mounted on the top side of this supporting member, up under the tin. Sockets, wired in parallel, were of the surface mounting variety with pull chains.

The whole reflector assembly was

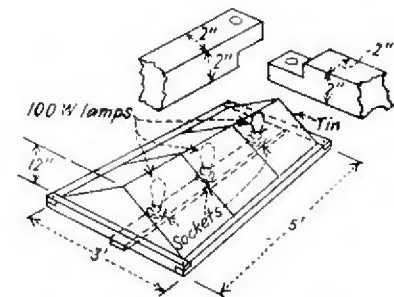

fastened to the ceiling by suspending it on heavy wires, one from each of the corner bolts, with the lower edge of the assembly $6\frac{1}{2}$ ft. from the floor. Finished, it casts no shadows, does not cause eyestrain as direct light in the eyes is avoided. Three 100 watt lamps seem to give best all-around results.

If the seams in the various sections of metal, indicated by lines in Fig. 2, are made in the same manner as seams in a standard metal roof each sheet will be self-supporting along the ridge and sides. A tinner will do a business-like job at small cost if you do not care to tackle it yourself. A little brown stain on all wood work gives the thing class.

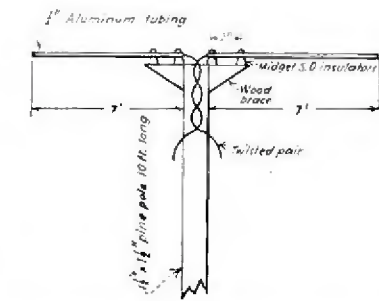

Noise-Detecting Superhet

By Harry D. Hooton

A difficult problem encountered in modern installation work is the locating of noise-free positions for the new all-wave receiver antennas. The time-worn advice "erect the antenna as high as possible" is no longer sufficient, especially near steel buildings, telegraph and trolley wires and where definite zones of interference exist.

To test for good antenna position before making critical installations I use a three-tube shortwave superhet designed especially for noise detection. The circuit, illustrated, is conventional in all respects save the detector, which is purposely of the square-law, or grid leak and condenser, variety. This type of detector is very sensitive to noise.

The two r.f. coils are non-removable and cover the range from 25 to 50 meters. The i.f. transformers are of the iron-core type, peaked at 456 kc. Other parts values are indicated on the diagram. The probing antenna (upper sketch) is a short doublet mounted on a pole.

In use, the outfit is set up on the spot and the probing antenna turned until maximum or minimum noise pickup is obtained. Pickup is best off the flat sides of the probing doublet. Thus the final, permanent doublet may be erected at right angles to noise sources with the assurance that results will be the best obtainable in each location. It is also possible, by this same method, to place antennas in quiet zones so that their directional characteristics are utilized.

The entire receiver, including batteries, is housed in a portable metal case 7x9x12 in. overall.

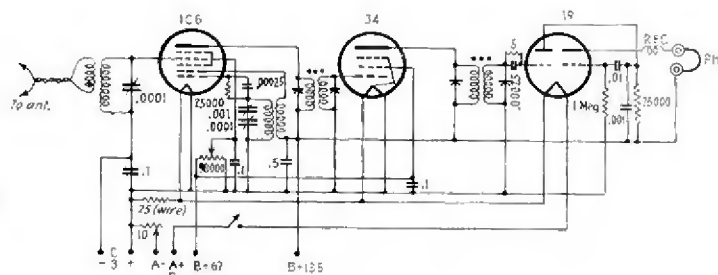

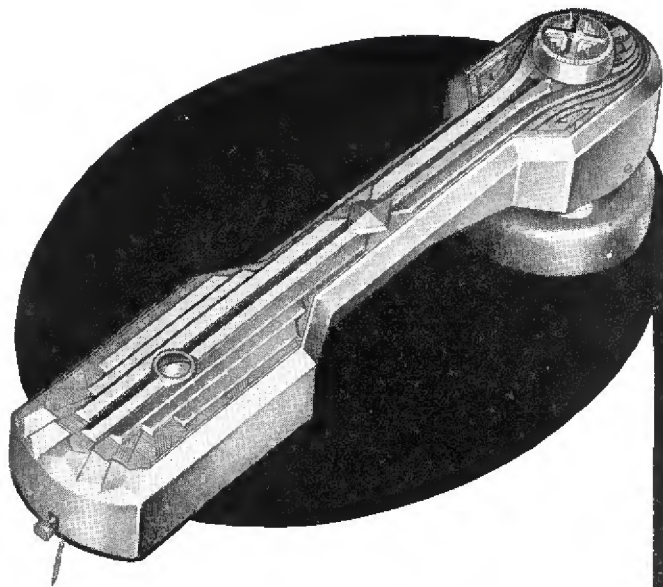

PICK-UPS!

... precision built to meet every requirement ...

• Ever since their introduction to the market, Webster Electric Pick-ups have been noted for their precision construction, tone quality and beauty of appearance.

Today, Webster Electric can offer the manufacturer practically any frequency characteristic he desires in phonograph pick-up performance.

Webster Electric Pick-ups are available in both magnetic and crystal types with standard, high fidelity or "ear-compensated" response characteristics—the latter a crystal type designed to give most pleasing reproduction.

Among the design features to be found in Webster Electric Pick-ups are: light needle weight, freedom from resonance peaks, low scratch and distortion level, chatter-proof bearings.

Bulletins describing Webster Electric Pick-up models will be sent upon request. We invite inquiries on specific requirements.

WEBSTER ELECTRIC COMPANY
Established 1909
RACINE, WISCONSIN, U. S. A.
Export Office:
15 Laight St., New York City

Wherever Sound  Must Fill Great Spaces

WEBSTER

ELECTRIC

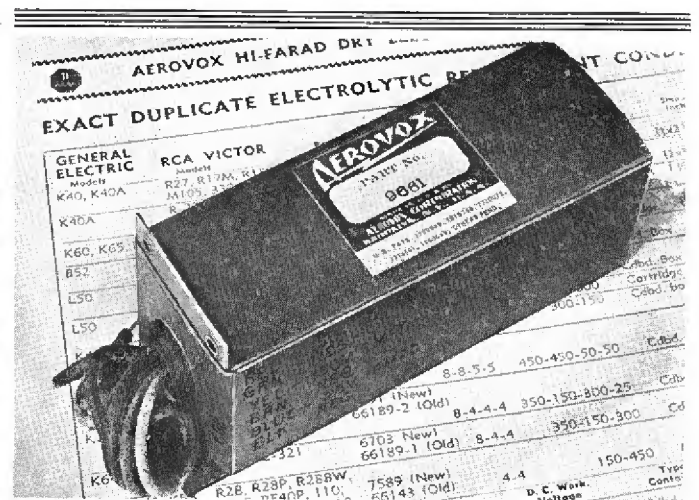

Exact duplicate electrolytic and paper condensers.

• Same electrical and mechanical characteristics as replaced unit.

• Plus AEROVOX superior quality for stay-pur job.

• Yet costing no more and usually less than improvised repairs with standard units.

Precisely Matched!

AEROVOX believes in Exact Duplicate Replacements for good radio servicing. • That's why it offers you (1) Precise data regarding condensers of most standard sets, and (2) Precise units exactly duplicating replaced condensers. • Write for latest catalog.

AEROVOX

CORPORATION

74 Washington St. :: :: Brooklyn, N. Y.

110 VOLTS AC ANYWHERE

With Katolight Jr. Complete light plant for \$59.95.

Electricity at price anyone can afford. Dealers you can sell the Katolight Jr. Each plant sold creates lifetime user for lamps, motors, wiring, Radio and appliances.

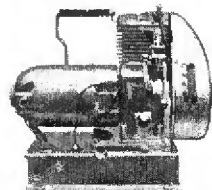

Make folks without electricity into customers.

	List Price
6 V., 150 Watts.....	\$59.95
12 V., 200 Watts.....	62.00
32 V., 300 Watts.....	65.00
110 V., 300 Watts.....	69.00
110 V., A.C., 60 Cy., 300 Watts.....	84.00

Dealers & Jobbers write or wire for details

Kato Engineering Co., Mankato, Minn., U. S. A.

Now Ready!

1936 Edition "Verified" Directory of Electrical Wholesalers

Completely revised, with many new listings

PLACE YOUR ORDER NOW

Single Copies, \$15.00. Additional Copies, \$7.50 each

ELECTRICAL WHOLESALING

330 W. 42nd Street

New York, N. Y.

A.F. Beat Oscillator

By V. W. Hodge

The diagrammed and pictured audio oscillator is simple to build from parts found around most shops and quite effective for many general servicing uses, such as showing up rattles in speakers, etc. About the only parts I had to buy were the two i.f. coils and their associated trimmers.

The cabinet was obtained from an old Silver-Marshall shortwave converter. A sheet-metal subpanel was used to mount the sockets and keep wiring, condensers and other parts nicely out of sight. The variable condenser substituted for one of the i.f. transformer trimmers is a small, vernier type with one rotor plate. Its capacity is not critical, just so it gives a good frequency spread over the dial. Don't skimp on the bypass condensers, however. These are important.

All tubes, except the rectifier in powerpack, are 27's. Other tubes could be used but I had plenty of 27's!

The i.f. coils selected in my case were Sickles No. 600, shielded 175 kc. units. The circuit is simple and should present no particular construction trouble. It comprises two oscillators adjusted to 175 kc. The variable condenser mentioned is substituted for the trimmer on one winding of the lower oscillator. The trimmer is disconnected. Set the two oscillators so that with the variable at minimum capacity they both work at the same frequency, or zero beat. Now, as the dial on the variable is turned the frequency of the lower oscillator will be changed. The resulting heterodyne is picked up by the single turn coupling coils and fed to the 27 detector, then amplified by the single stage audio amplifier.

It was found that the detector picked up sufficient energy from the oscillators just by looping a turn of hookup wire around the glass of each one. Closer coupling than this should be avoided. A quick test to determine when the oscillators start working is to measure the plate current. It will decrease when the tubes start to oscillate.

I.f. coils usually come with the trimmers set nearly at 175 kc. This frequency can be checked by feeding the

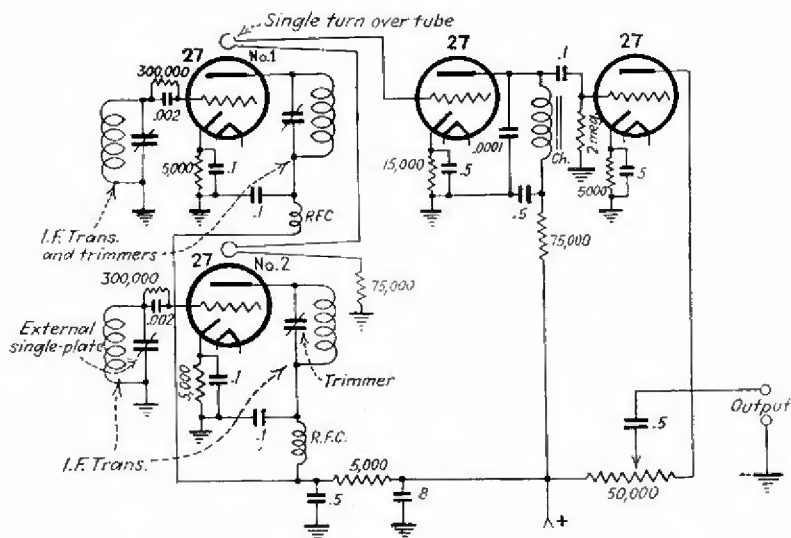

output of the upper oscillator, by means of a length of wire wound around the tube, to the first i.f. stage of a radio receiver having a 175 kc. intermediate. Of course, it isn't essential that 175 kc. be used as the "reference point," but it is felt that this particular frequency is most suitable as coils are readily obtained and trimmer adjustments are not critical.

The audio choke used in my instrument is a Jefferson 466-240, 200 henry unit. I found that with either resistance or transformer coupling it was difficult to get a smooth pattern on an oscillograph. This choke should be mounted as far from the plate and filament supply transformers as possible to reduce the possibility of picking up a.c. hum.

universally and the de-coupling resistor placed between the diode return of the i.f. winding and the volume grid connected to the first audio grid of the same tube is frequently ineffective. Trouble of this variety can be greatly minimized by inserting a 50,000 ohm resistor and two condenser filters in the second detector output lead as shown and a 50,000 ohm resistor in place of the de-coupling unit ordinarily included in the original circuit.

Do not use larger condensers than those indicated or audio quality will suffer.

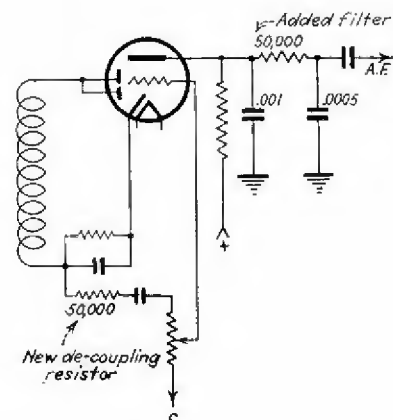

Carrier Filtering

By Gerald Evans

Whistles in superheterodynes are generally caused by the oscillator beating against unwanted stations but frequently occur, also, due to the presence of r.f. along with audio in the output of the second detector. If the set employs a three-gang condenser and an r.f. stage preceding the second detector r.f. feedback trouble becomes serious and can be eliminated only by proper filtering the carrier from the audio component. Such trouble sometimes occurs even in sets without an r.f. stage.

Feedback of this variety adds a "groan" background to stations. Whistles at various points on the dial and good imitations of bad motorboating also indicate this form of trouble. Noise on distant stations when the volume control is nearly full on, becoming worse at the low frequency end of the dial, are further indications. If the whistling varies when the speaker wires are brought near the antenna circuit this is definite proof of the fault.

Diode detectors are now used almost

"Hum In Battery Sets"

By H. H. Beechill

I have been called upon to service two or three trf battery receivers sold by Sears-Roebuck and the complaint was poor sensitivity plus what sounded like a.c. hum. Only a few locals could be heard.

Upon examination I discovered that an audio transformer is mounted close to an unshielded r.f. tube and that when placing my hand on this tube hum disappeared. This noise is caused by low-frequency modulation of the carrier and may be temporarily cured by changing the tube. For permanent cure shield it.

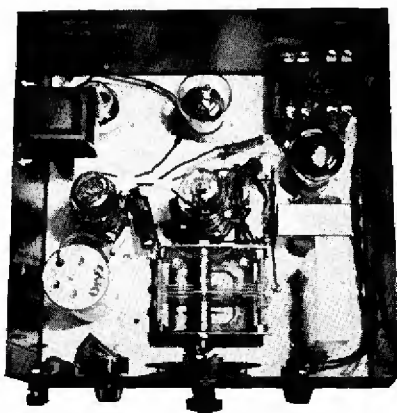

"NE PLUS ULTRA!"

Exclaimed Julius Caesar, whenever he waxed enthusiastic about something PERFECT . . . and if you spoke Latin, that's the way you would describe the Index to Rider's Manuals.



Suppose you have a set on your bench . . . You want service data . . . What's the first step? There's no sense dragging down all the Manuals and hunting through the pages . . . So you look in the 96-page index! It's easy to find the manufacturers because their names are alphabetically arranged and for further convenience, identifying group letters are on the top of each page.

To find the model number takes but a moment, because they are listed numerically . . . You want the schematic, the socket layout, alignment data? The volume and page number are indicated . . . *Everything you need is in the Index!*

Just remember this:

EVERYTHING ON EVERY PAGE IS INDEXED

AND here's just one more reason why thousands of Servicemen throughout the world are using Rider Manuals—No Manual can ever be better than its Index and the Rider Manual Index is NE PLUS ULTRA.

Incidentally, are you spending AN HOUR A DAY WITH RIDER?

New PIONEER Blue Diamond
110 v. A.C.
GAS-ELECTRIC PLANT
FOR ONLY \$79.95

ELECTION YEAR!
IMAGINE POSSIBILITIES
FOR P. A. WORK!

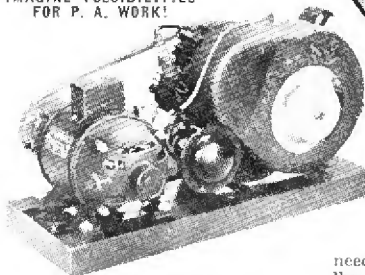

ALSO SUPPLIES DIRECT CURRENT FOR CHARGING ALL 6v. BATTERIES

PIONEER GEN-E-MOTOR CORP.
464-F West Superior St., Chicago, Ill.
Rush full information on the new PIONEER "Blue Diamond" 110 v. 300 watt AC Gas-Electric Generator.

Name

Address

City State

For the first time—an AC—110 volt 300 watt plant—for less than \$200.00. It is ideal for sound systems, mobile radio units, farm lighting systems—any place where a light weight, dependable, yet economical power plant is needed! Weighs less than 80 lbs.—costs only \$79.95—operates 12 hours on a gallon of gas! Has a 6 volt direct current winding for charging batteries!

Also write for details Pioneer Series 1 6-volt 150 and 200 watt plants, 12-volt 150 and 250 watt plants and 32 and 110-volt 250 watt plants. Sensational sellers as low as \$49.95.

\$49.95

CLAROSTAT composition-element controls (left) offer widest range of resistance values and tapers in limited-current circuits.

CLAROSTAT wire-wound controls (right) provide adequate current-handling capacity with wide range of resistance values and tapers.

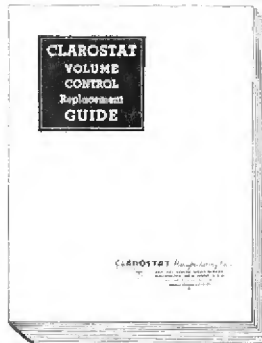
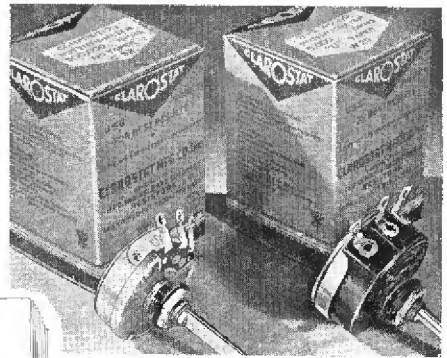

Get Your Copy!

Ask your jobber for a copy of this handy guide. Or write us direct on your business letterhead.

EXACT DUPLICATE Volume Controls

WHY improvise? It doesn't pay to use just any control in servicing sets. • For a "stay-put", profitable job, use a CLAROSTAT Exact Duplicate Control. • The big 80-page Guide specifies the exact unit to use. And your jobber can supply that unit. • Result: A satisfied customer; a clean profit; no kicks; a growing trade.

CLAROSTAT MANUFACTURING CO., Inc.
285-7 N. SIXTH ST. :: BROOKLYN, N. Y.

THE RED HEAD AUTO ANTENNA FOR DX

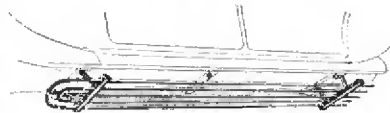

Quick installation on any car. Max. pick up. Min. capacity. Made to last.

THE RED HEAD ANTENNA WILL SATISFY BOTH YOU AND YOUR CUSTOMER. LIST \$2.50

NEW RED HEAD JR. NEW
Vertical plate construction. Scientifically correct. Priced \$1.65 at only

MANUFACTURED BY SCHIFFMANN BROS., 3840 No. Ashland Ave., Chicago, Ill.

An easy Job for the Jobber to sell.
Write for Details

A NEW SIGNAL GENERATOR THAT DOES EVERYTHING

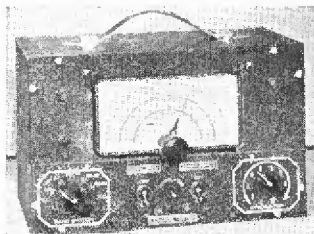

R.F. coverage 100 kc. to 20 mc. all on fundamentals. Dial is direct reading in frequencies. Modulated at 1000 cycles. Included or excluded by front panel switch.
R.F. output may be taken from high or low impedance post. Separate audio output. A.C. or D.C. operation.
Two extra posts on front panel enable leakage tests for condensers, tube and other high resistance circuits otherwise difficult to test.

Model T-37, wired, calibrated, tested; complete with three tubes in shielded cabinet with carrying handle and instructions (shipping weight 7 lbs.)

\$12.40

SUPERIOR INSTRUMENTS COMPANY
139 Cedar Street, NEW YORK, N. Y. Dept. 371

AK 7D, 217D, 427D, 667D.

Squealing at low volume levels . . . Replace condenser C18 as it has probably developed leakage. Use an 8 mike, 400 volt unit. Sometimes one section of the i.f. transformer T5 will also be found open.

CLARION AC 40.

Oscillation . . . Place .002 from one side of power line to chassis.

CROSLEY 170, 171.

Loss of volume and noisy operation . . . Examine .0005 tubular condenser in series with antenna coil.

FADA 66.

Oscillation on one of more shortwave bands . . . Connect 300 ohm, non-inductive resistor in series with the control grid lead to the 24A first detector-oscillator.

GE K43.

A.c. hum, especially noticeable on stations, in early models . . . Connect 500 ohm resistor from set side of .01 antenna condenser to chassis. Later models came through with an r.f. choke in this position.

GE 118.

Continual frying noise with volume control either at minimum or at maximum . . . Frequently due to induction from the a.c. transformer leads running under the resistors. Using an insulated screwdriver, move the leads down or out until the noise stops.

LYRIC 56.

Distortion at low volume control settings, clear reception when control is advanced . . . Defective 1 megohm resistor located on power transformer; colored brown, black and green.

MAJESTIC 130A.

Flat tone and loss of volume, all voltages correct . . . Check speaker field coil for open. An analyzer will not show this fault if tests are run from the chassis.

MAJESTIC 290.

Inoperative suppressor control . . . Caused generally by leaky or shorted 10-mike, 50-volt condenser marked C-8 on diagram and connected from G57 audio tube cathode to one end of volume control. Distortion . . . If present only when volume control is advanced look for leaky C-10 or C-20 audio coupling condensers.

PHILCO 71.

Intermittent operation, volume dropping 50 per cent, proper operation restored the instant an analyzer plug is inserted for test . . . Check voltage divider section between screen grid and cathode of second detector.

PHILCO 90.

Microphonic howl, stops if oscillator or i.f. coil cans are pressed or squeezed . . . Remove coil assemblies and melt paraffin over the forms to hold leads solidly in place. Paper around the coils frequently becomes loose, vibrates and moves leads sufficiently to cause trouble.

PILOT DRAGON 10.

A.c. hum level abnormally high . . . Look for ground at the reflector mounted behind the pilot light. Sharp corner of this reflector frequently pierces the small piece of fibre insulation included to prevent shorting of filaments to ground.

RCA-VICTOR 44.

Fading on locals . . . May be due to corroded center friction contact of volume control arm.

RCA-VICTOR 47.

Fades on locals, volume can be brought back by snapping a.c. switch on and off . . . Plate supply of first and second r.f. tubes feeds through phonorecord switch and poor contact here is usual cause of grief.

RCA TMV-97-C.

When using this oscillator be sure the shielded lead from the output connection is fabric-covered or the B-battery will run down in the event the shielding touches the output jack.

SPARTON 61, 62.

Tunable squeal all over dial in these a.c.-d.c. models . . . Check 5 mike, 165 volt section of filter condenser block for leakage. If present, cut green lead and replace with 8 mike, 200 volt unit.

STEWART-WARNER R136, R137, R138.

Poor sensitivity at low frequency end of broadcast band, inability to align or calibrate at 600 kc., oscillation at low frequency end of broadcast band . . . Almost always due to large change in capacity of small bakelite fixed condenser connected across oscillator shunt padding trimmer. Unit colored brown, brown, black. Replace with .000011 original replacement number 85434.

STEWART-WARNER.

Some models of auto-radios have loud hum when volume control is at low setting . . . Loosen the r.f. coils and shield wire from volume control to a coupling condenser located under these coil cans on the bottom of the chassis. The shield should be soldered to the grounded terminal of the volume control. Hum is caused by inductive pickup from the A wire to the vibrator being alongside the wire to be shielded. Loud hum and chattering of relay, weak, distorted reception . . . Open plate circuit to one plate of 84. May be bad socket contact.

SILVERTONE 1801 AC-DC.

Undue hum after regular filter replacement . . . Tie the cathodes of the 25Z5 together. The filter arrangement of this set is identical with that of a Sparton 57 so that a filter block for this latter make will work quite satisfactory if the original replacement is not obtainable. Care must be exercised because the color coding of the leads supplied with the two blocks is not identical. Both schematics must be on hand to avoid wiring error.

STROMBERG 641.

Intermittent reception or fading . . . Often caused by loose lugs on 800 ohm volume control.

US GLORITONE 27.

Low volume . . . Frequently due to defective speaker field. Coil may test ok with an ohmmeter but opens under load. Test by touching metal screwdriver to core with set in operation, note magnetism.

ZENETTE CH SERIES.

Excessive regeneration and no volume . . . Often due to defective electrolytic located in square can at far end of chassis (left side) bypassing choke located underneath chassis. Choking up when volume control is advanced or tuning dial shifted . . . Caused by 500,000-ohm plate resistor in a.v.c. tube dropping in value.

ZENITH 760.

Hum, after regular values of filter condensers have been installed . . . May be reduced by bypassing the .5 bypass condenser next to primary of input transformer with 8 mike electrolytic. Distortion . . . Bypass center-tap of volume control to ground with .00015 mica unit. This removes the r.f. load on the grid of the first a.f. tube and allows greater a.f. amplification.

Send me complete details about shop equipment I can get free with N. U. radio tubes!

Name

Street

City

State



COME ON DOWN THE OPEN ROAD TO MORE RADIO SERVICE BUSINESS, WITH NATIONAL UNION RADIO TUBES PLUS FREE EQUIPMENT ASK NOW...

How can I get these:

Tube Testers Oscillographs
 Set Analyzers Metal Cabinets
 Shop Coats Sound Equipment

**NATIONAL UNION RADIO CORP. OF NEW YORK
 570 LEXINGTON AVENUE, NEW YORK, N. Y.**

Send Coupon NOW!

RM336

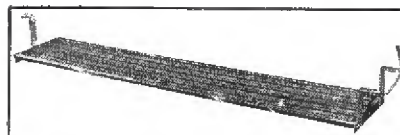

**THE PERFECT
 AUTO AERIAL**

*Check these many
 fine features*

- Super Sensitive Pick-Up.
- Live Rubber Processed.
- Rust-Rumble Proof.
- New Chevron Mesh.
- Integral Lead-In.
- Maximum Signal Pick-Up.
- Deterioration Proof.
- Cannot Corrode.
- Improves Reception.
- Rubber Protected.
- Cannot Weave or Bend.

RUB-A-TENNA

A GOOD automobile radio can be no better than its aerial—so by all means get a good aerial—a Rub-A-Tenna. It will enable you to get the utmost efficiency from your receiver. It is scientifically designed to perform. It is styled for to-day's streamlined car. It is built to last. Its super-sensitive metallic fabrication is processed in live rubber. Measures 6x12 inches to fit all cars.

ONLY \$2.75 FROM YOUR DEALER

**CONSOLIDATED
 WIRE AND
 ASSOCIATED
 CORPORATIONS**
 CHICAGO

ORDER ONE TODAY

**OPERADIO means the
 finest in RADIO SET
 REPLACEMENT
 SPEAKERS**

Our Junior Series are the favorite of the country's service men. They do the job they should do better and they make you more money than installing cones.

Address Dept. R.R. for
 Catalog 10D.

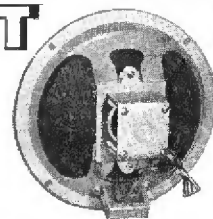

**OPERADIO
 MANUFACTURING COMPANY
 ST. CHARLES, ILLINOIS**

RADIO MANUFACTURERS ONLY!

PROFIT PLANNING

You will agree that it is most important, when you are planning for increased profits, to begin by stopping existing waste and increasing results from each dollar spent. Direct-Mail advertising waste comes from using out of date, poor lists.

To get maximum results from your efforts and to get "your message to Garcia" you must have effective distribution.

THE ANSWER

Only "1936" streamlined mailing lists will make your direct-mail advertising pay out this year—old, out of date lists will not do the job.

ACTION

Present day marketing demands speedy action. Send for your copy of the new state count and price folder of the McGraw-Hill list of the radio trade. Plan to use these verified and daily corrected lists on your next mailing.

Action on your part brings action by your dealer prospects.

DIRECT-MAIL DIVISION

McGRAW-HILL PUBLISHING CO., INC., 330 WEST 42ND STREET, NEW YORK, N. Y.

New Tube Socket Connections

(Seen from below)

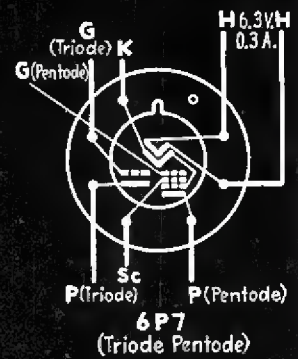
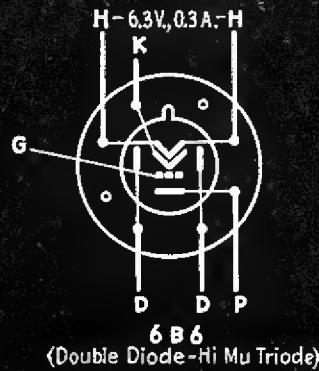
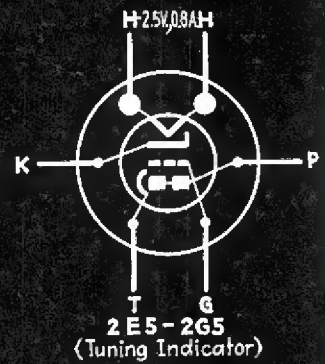
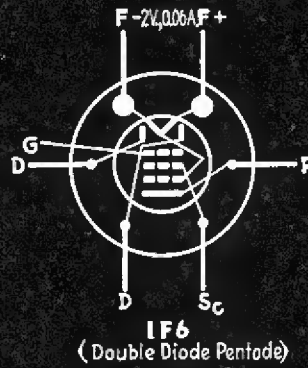
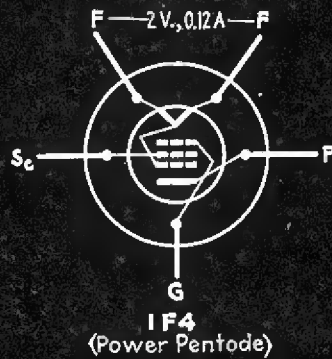
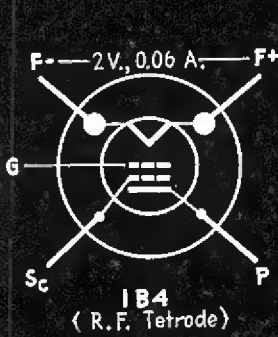

Another RADIO RETAILING
Rapid Reference Chart

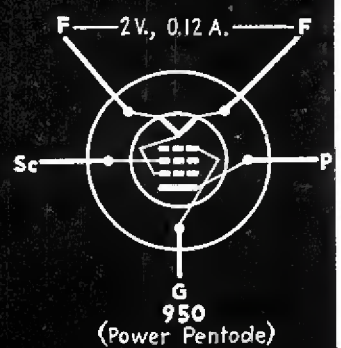



The most effective
tube seller ever made

Model MC



RADIOTECHNIC LABORATORY
WILMETTE ILLINOIS

INDEX TO ADVERTISERS

	Page		Page
Aerovox Corp.	50	Radiotechnic Labs.	56
American Television & Radio Mfg. Co.	38	Raytheon Production Corp.	31
Ansley Radio Corp.	40	RCA Mfg. Co.	Front Cover
Arcturus Radio Tube Co.	37	RCA Mfg. Co.	28b, 28c, 37
Atwater-Kent Mfg. Co.	28d	Rider, John F.	52
Belmont Radio Corp.	8	Schiffman Bros.	52
Cinaudagraph Corp.	6	Solar Mfg. Corp.	46
Clarostat Mfg. Co.	52	Sparks-Withington Co.	24
Consolidated Wire & Cable Ass'd Corp.	54	Stewart Warner Corp.	22
Continental Radio & Tele. Corp.	20	Stromberg-Carlson Tele. Mfg. Co.	2
Cornish Wire Co.	41	Supreme Instrument Co.	44
Crosley Radio Corp.	6	Superior Instrument Co.	52
	Inside Back Cover	Triplet Electrical Instr. Co.	46
Fox Sound Equipment Corp.	46	Tungsol Radio Tubes, Inc.	3
General Electric Co.	Back Cover	Universal Microphone Co., Ltd.	38
Hygrade Sylvania Corp.	39	USL Battery Corp.	41
Inland Mfg. Co.	36	Utah Radio Products Co.	40
Kato Engineering Co.	50	Ward Products Co.	38
Ken-Rad Corp., Inc., The.	41	Webster Co.	46
Mallory & Co., Inc., P. R.	6	Webster Electric Co.	50
	Inside Front Cover	Weston Electrical Instr. Corp.	42
National Union Radio Corp.	54	Wincharger Corp.	7
Noblitt-Sparks Ind., Inc.	4, 5		
Operadio Mfg. Co.	54	SEARCHLIGHT SECTION	
Oxford-Tartak Radio Corp.	40	<i>Classified Advertising</i>	
Pioneer Gen-E Motor Corp.	52	Classification	Page
		EDUCATIONAL COURSES	
		Capitol Radio Engr. Instr.	56
		RADIO STOCKS	
		Allied Radio Corp.	56

McGraw-Hill Publishing Company, Inc., 330 West 42d Street, New York, N. Y. Branch offices: 520 North Michigan Ave., Chicago; 883 Mission St., San Francisco; Aldwych House, Aldwych, London, W. C. 2; Washington; Philadelphia; Cleveland; Detroit; St. Louis; Boston; Atlanta, Ga.

SEARCHLIGHT SECTION



Mr. E. H. Rietzke, President and originator of the first thorough course in PRACTICAL RADIO ENGINEERING.

THE SERVICE BUSINESS is "going places"

... are you?

During the next two years the service business is going to make real progress, and those men who have equipped themselves with the necessary TECHNICAL TRAINING are going to "cash in" on it!

CREI Training Gives Every Man The Opportunity To Get Ahead

Hundreds of men in every branch of Radio have forged ahead as the result of CREI training. Our new course in SERVICE AND PUBLIC ADDRESS ENGINEERING is written especially for experienced Service Men who WANT a future. Write us and see what we can do for YOU!

★ CAPITOL RADIO ENGINEERING INSTITUTE
DEPT. RR-5

14TH & PARK ROAD WASHINGTON, D. C.
29 BROADWAY NEW YORK CITY

MAIL THIS COUPON TODAY!

Please send me complete details and illustrated booklet regarding your new Course in Service and Public Address Engineering.

Name
Address
City

10,000 RADIO PARTS



Parts to cover every radio need—get them from ALLIED. Fresh, clean stocks of highest quality—all at lowest prices. Order from the new Radio's Leading Supply Guide.

ALLIED RADIO

833 W. Jackson Blvd. Dept. R.R. Chicago, Illinois

Send me your FREE Radio Catalog.

Name
Address

"SEARCHLIGHT" RATES
Radio Retailing

UNDISPLAYED

Positions Vacant and all other classifications, excepting Equipment, 15 cents a word, minimum charge \$3.00.

Positions Wanted (full or part-time salaried employment only) 1/2 the above rates, payable in advance.

See 1 on Box Numbers.

INFORMATION:

Proposals, 50 cents a line an insertion.

Box Numbers in care of our New York, Chicago or San Francisco offices count 10 words additional in undisplayed ads. Replies forwarded without extra charge.

Discount of 10% if full payment is made in advance for four consecutive insertions of undisplayed ads (not including proposals).

DISPLAYED

1 inch\$8.00
2 to 3 inches..... 7.80 an inch
4 to 7 inches..... 7.60 an inch

Other spaces and contract rates on request.

An advertising inch is measured vertically on one column, 3 columns—30 inches—to a page.

33 $\frac{1}{3}$ % INCREASE IN CROSLEY DOLLAR VOLUME SINCE JANUARY 1, 1936

. . . over same period last year . . . and last year broke all previous records!

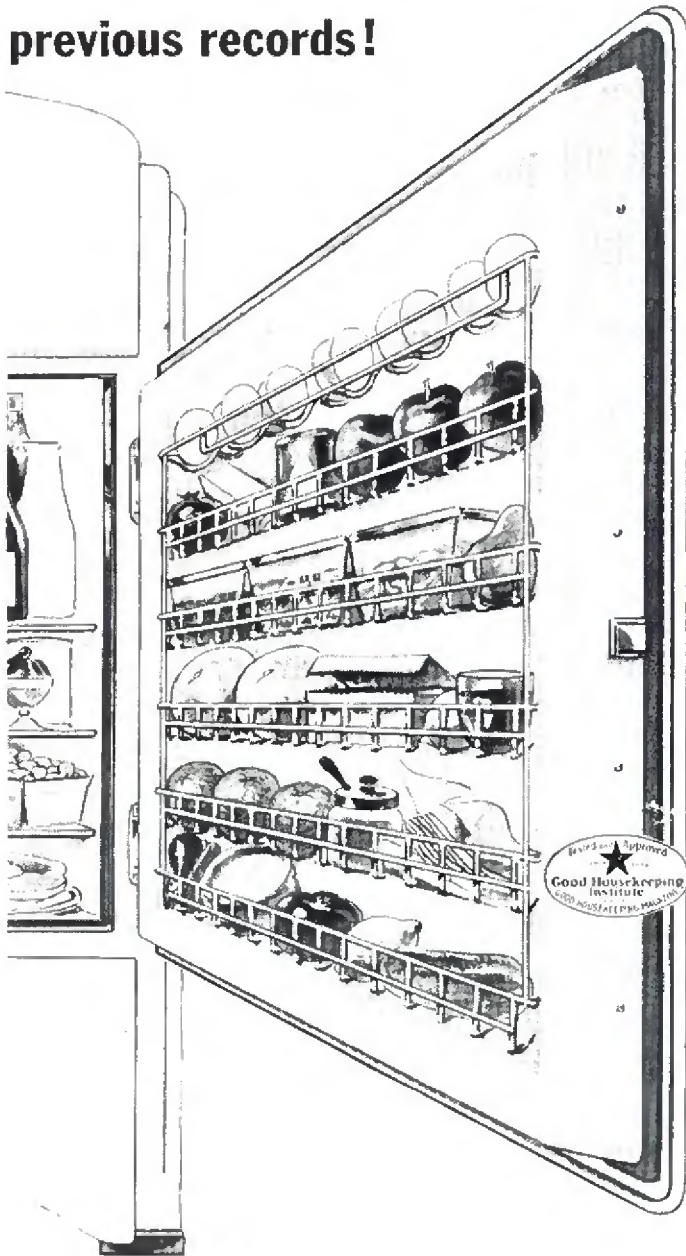

HOUSEWIVES proclaim Shelvador the greatest household success of the generation. They rush to buy this—the only truly modern refrigerator.

And dealers everywhere are snapping up the Crosley franchise—the greatest money-maker of the times.

this much more in
a **SHELVADOR**



THE WORLD'S MOST BEAUTIFUL REFRIGERATOR

TO DEALERS, this brief suggestion—backed by PROOF: "The sooner you handle Crosley, the more you profit!"

Priced from \$99.50 to \$244.95, including delivery, installation. Five-Year Protection Plan.

(All prices slightly higher in Florida, Texas, Rocky Mountain States and West.)

THE CROSLEY RADIO CORPORATION, CINCINNATI - POWEL CROSLEY, Jr., President



MEANS BUSINESS

The volume of General Electric Radio sales for the current season has made record-breaking advances. In fact, G-E Radio sales are the greatest in the history of the Company. G.E. has moved forward to a dominating position in the radio industry.

With a background of more than a quarter of a century of distinguished radio achievements, General Electric is expanding its research and development facilities . . . strengthening its field merchandising force . . . to make even greater contributions to radio engineering, manufacturing and

merchandising for this year and the years to come.

General Electric Radio dealers know that they can count on consumer acceptance, ease of handling, quick turnover and powerful sales promotion assistance when they feature General Electric Radio. The entire General Electric Radio factory program is built to help dealers make money.

Unquestionably, General Electric Radio is the right line upon which you can build a permanent business of volume sales and growing profits, for G.E. means business — and more business every year!

**Your nearest General Electric Radio Distributor
will gladly give you complete information.**

GENERAL  **ELECTRIC**

THE ORIGINAL METAL-TUBE RADIO

APPLIANCE AND MERCHANDISE DEPARTMENT, GENERAL ELECTRIC COMPANY, BRIDGEPORT, CONN.